

SPORT AMERICAN 167
(3-25-88)

PEARSON

MANUAL

REVISED July 15, 1988

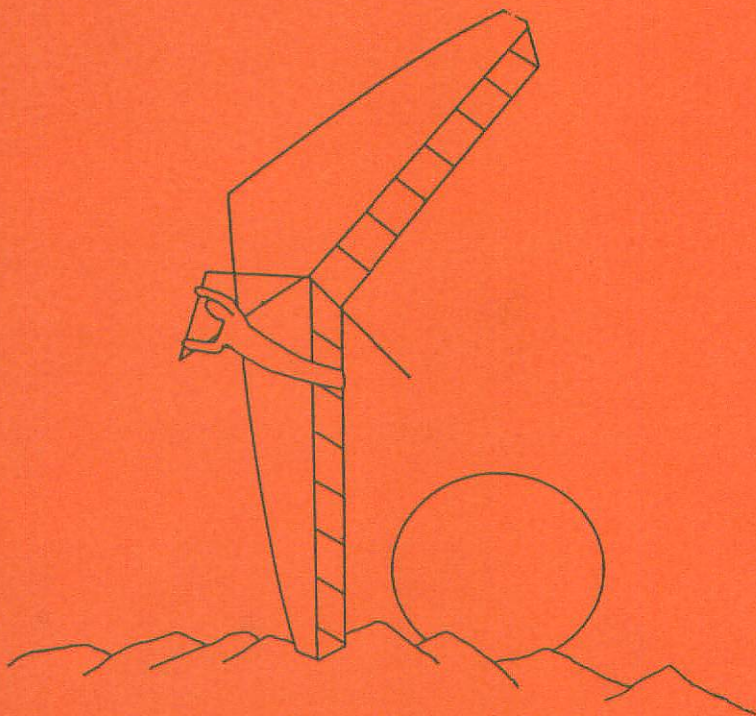

WILLSWING

1208H E. Walnut, Santa Ana, CA 92701 (714) 547-1344 / 6366



Serial Number

TABLE OF CONTENTS

SECTION ONE - OWNER'S SECTION

- Page 1 - Introduction
- Page 2 - Technical Information
- Page 4 - Set Up Procedure
- Page 26 - Pre-Flight Procedure
- Page 38 - Installing the Nose Cone
- Page 40 - Laying the Glider Flat
- Page 41 - Launching Flying and Landing
- Page 46 - Breakdown Procedure
- Page 56 - Tuning Summary & Maintenance
- Page 64 - Car Top Mounting
- Page 66 - Compliance Verification Sheet

SECTION TWO SERVICE SECTION

- Page 1 - Post Shipment Assembly
- Page 4 - Set-Up Inspection & Test Flight
- Page 6 - Tuning
- Page 10 - Removing the Sail
- Page 12 - Re-Installing the Sail

SECTION THREE FRAME PLANS & EXPLODED VIEWS

INTRODUCTION

Congratulations! You are now the proud owner of one of the finest footlaunched soaring flex-wings manufactured today. Your WILLS WING SPORT is the product of an extensive design and development program aimed at optimizing your level of safety and confidence as a pilot, while providing you with a highly competitive level of sink rate and glide ratio performance.

Please read and be sure you thoroughly understand this manual before flying your SPORT. Hang gliding is an extremely demanding sport requiring exceptional levels of attention, judgement, maturity, and self discipline. It is unlikely that you will be able to participate in it safely unless you make a conscious and continual commitment to your own safety. Hang gliding is a dangerous sport and may result in injury and death even when practiced by a competent pilot using proper equipment. This glider is not covered by product liability insurance, nor has it been designed, manufactured or tested to any federal or state government airworthiness standards or regulations. Do not fly it unless you are willing to assume personally all risks inherent in the sport of hang gliding, and all responsibility for any property damage, injury, or death which may result from your use of this hang glider. Safe operation of this glider requires a pilot proficiency level equivalent to that of a United States Hang Gliding Association Hang III rating, as well as an equivalent level of knowledge and understanding of those wind and weather conditions which may compromise the pilot's safe control of the hang glider. In particular, be advised that gusty winds or turbulent conditions may interfere with even an expert pilot's ability to safely control the hang glider, and may cause it to crash. Be sure you are thoroughly familiar with the set up, breakdown, preflight, and maintenance procedures as described in this manual. Make sure you follow all appropriate procedures every time you fly. Never take anything for granted in hang gliding; if you are in doubt about anything, stop and figure it out, consult your manual, your dealer, or Wills Wing, Inc.

We would like to welcome you to the Wills Wing family of pilots, and wish you a safe and enjoyable flying career.

Wills Wing, Inc.

TECHNICAL INFORMATION

The SPORT has been tested and found to comply with the 1986 HGMA Airworthiness Requirements. These standards require:

An ultimate positive load test at the maximum lift angle of attack at a speed of 65 mph.

An ultimate negative 30 degree angle of attack test at a speed of 46 mph.

An ultimate negative 150 degree angle of attack test at a speed of 32 mph.

Pitching moments tests at speeds of 20 mph, 30 mph, and 40 mph which show the glider to be pitch stable over an extended range of angles of attack.

Flight tests which show the glider to be safely controllable and stable over a wide range of normal and abnormal flight modes and conditions.

NOTE: The SPORT was designed for footlaunched soaring flight. It was not designed to be towed, tethered, motorized, nor flown at angles of bank beyond 60 degrees or angles of pitch beyond 30 degrees. Operation in any of these modes may severely compromise your safety, and we strongly recommend against it. Should you decide to do so anyway, please avail yourself of the experience and expertise of those people who are qualified in that particular area, and please proceed with extreme caution. Please be advised that Wills Wing can in no way be responsible for the airworthiness or applicability to any specific purpose of any Wills Wing glider, except as described in the HGMA Airworthiness Standards.

In addition, please understand that flying any hang glider in the presence of turbulence or gusty winds can result in in flight inversion and structural failure of the glider, and in fatal injuries. Do not fly in turbulent or gusty conditions unless you recognize and wish to assume the associated risks.

Stall speed of the SPORT at maximum recommended wing loading is 25 mph.

Top speed of the SPORT at minimum recommended wing loading is greater than 35 mph.

**Recommended pilot weight,
for the Sport 167: 140 - 240 lbs.**

(Including all gear)

Flight operation of the SPORT should be limited to non acrobatic maneuvers, i.e. those in which the pitch angle will not exceed 30 degrees nose up or nose down from the horizon, and in which the bank angle will not exceed 60 degrees. The SPORT will strongly resist

spinning, and will tend to recover quickly from a spin once control pressures are relaxed without entering extreme attitudes and without extreme loss of altitude. Deliberate attempts to spin the glider may result in the glider becoming inverted and suffering a structural failure. No such attempt should ever be made.

The SPORT should not be flown at speeds in excess of 46 mph. This speed will generally correspond to a prone pilot position where the pilot has pulled forward such that the basetube lies across the middle of the thigh.

A USHGA pilot proficiency level of III or higher is required to fly the SPORT safely. Flight operation by unqualified pilots may be dangerous and is prohibited.

SPORT SET UP PROCEDURE

NOTE: Use of the specific techniques described in this manual will make the set up and break down procedures much easier to perform. Your dealer should go over the set up and break down procedures with you at the time the glider is delivered. The following procedural descriptions are not intended to be a substitute for this orientation process. However, you should read the manual carefully and follow the procedures as described.

- 1) With the glider in the bag, lay the glider on the ground, nose into the wind, with the bag zipper up. If the wind is more than 10 mph, lay the glider at right angles to the wind direction. (Fig 1)



Fig 1

- 2) Undo the zipper, and remove the battens from between the rear leading edges as shown. (Fig 2)

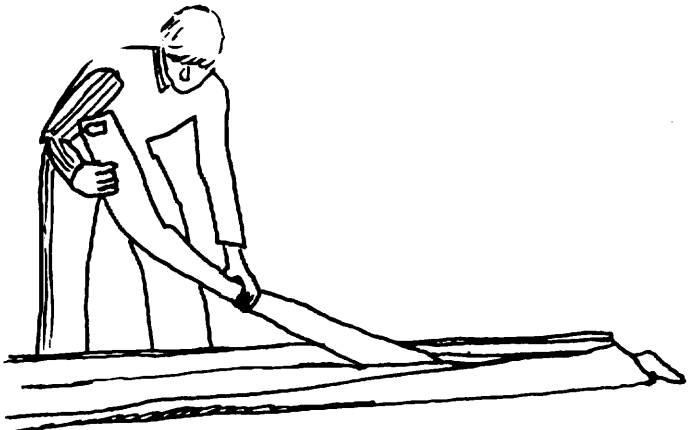

Fig 2

3) Undo the velcro securing the control bar, and fold the bar up and forward. (Fig 3)

CAUTION: Because of the design of the control bar apex "E" bracket, you MUST allow the control bar uprights to spread apart as you lift them up away from the glider. If you don't, you will bend the "U" channel bracket at the top of the control bar, bend or break the bolt which holds this bracket to the keel, strip the nut off of this bolt, crush the keel, or all of the above. The same is true if you try to fold the bar against the keel with the uprights spread.

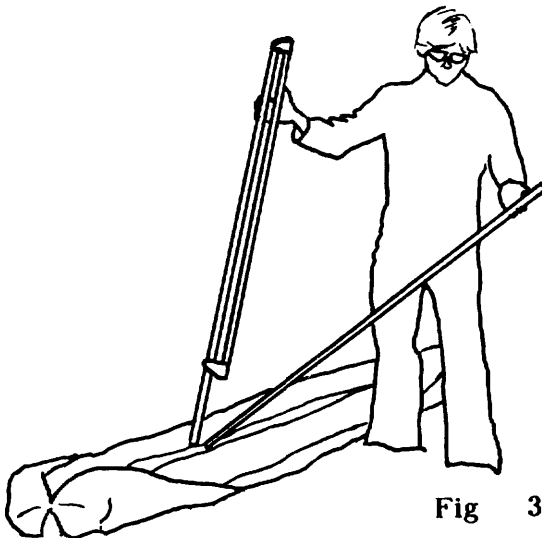

Fig 3

4) Attach the free end of the base tube to the downtube using the wing nut and safety provided.(fig 4 and 5)

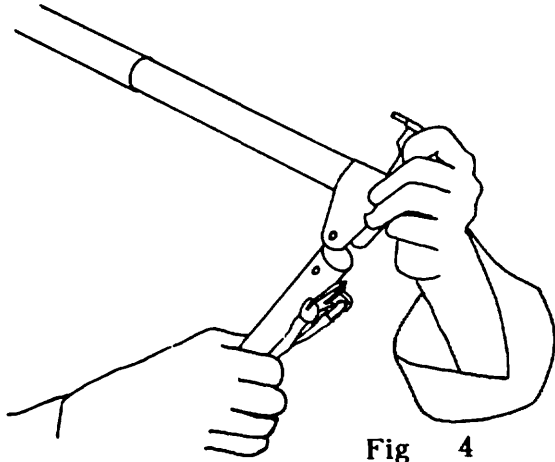

Fig 4

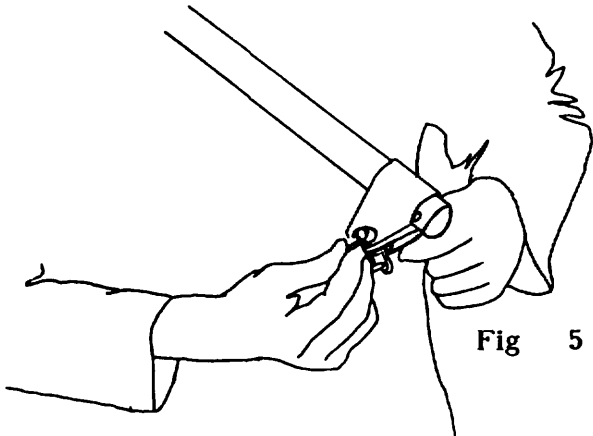

Fig 5

5) Flip the glider upright, holding the front wire to hold control bar forward, and rest the glider on the control bar. The glider should be nose into the wind if the wind is less than 10 mph, or at right angles to the wind if the wind is more than 10 mph.(fig 6 and 7)

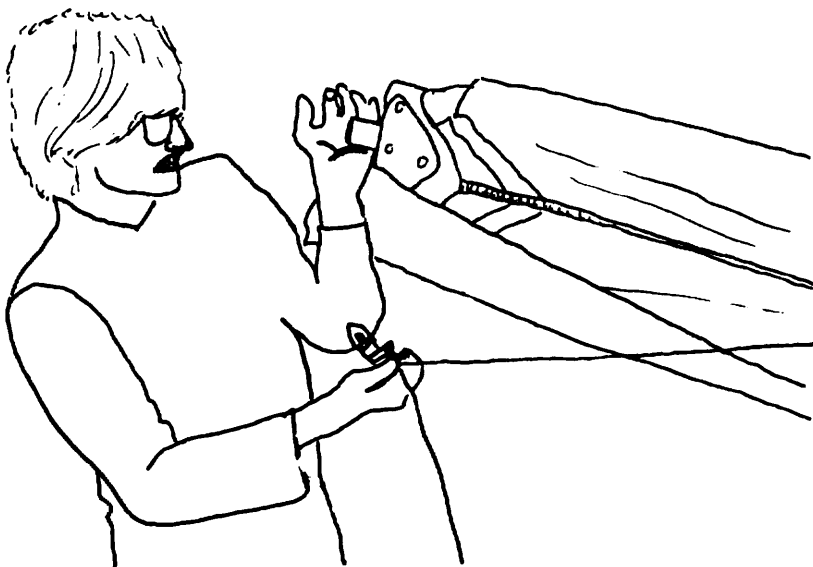

Fig 6

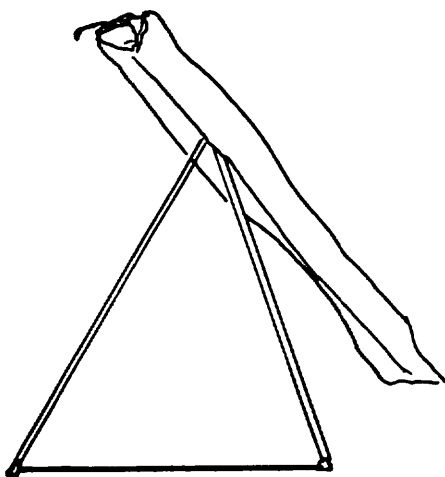

Fig 7

6) Remove the bag and all of the velcro straps. Spread the wings about half way, taking care that the bridles and top side wires are not wrapped around the keel or snagged on the keel hardware.

Check that the flex lock nut which secures the control bar top channel bracket to the keel is secure. On early models without the CG adjuster track, this nut is found at the top of the keel mounted kingpost base assembly. On later models, this nut is inverted (turned upside down) and is located in a recess in the bottom of the central channel in the CG track extrusion. On later models, a second flex lock nut is found at the top of the kingpost base assembly, and secures the kingpost base assembly in its longitudinal position in the CG track. YOU MUST check this nut for tightness, and check that the kingpost base assembly cannot slide in the track. See the section on trim and hang point adjustment in the service section for more information on the function of this assembly.

7) Lift the bridle ring off the kingpost base stud, and holding the ring and bridles behind the kingpost, install the kingpost onto the stud. (fig 8 and 9) Take care not to pinch the sail in the process. You must have the keel centered between the partially deployed leading edges in order to install the kingpost.

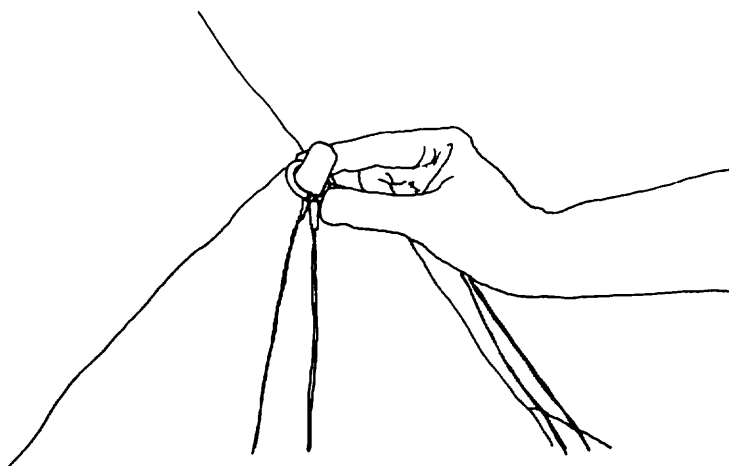

Fig 8

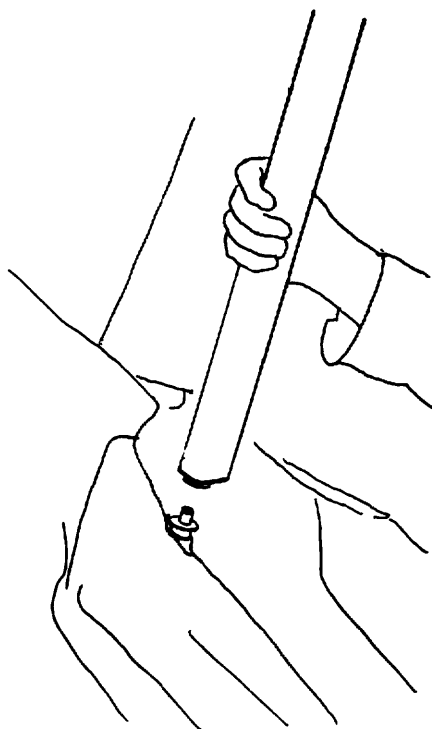

Fig 9

Clip the bridle ring into the snap hook that hangs from the back of the kingpost top. (fig 10) Make sure that the bridle ring has not been turned upside down and that there is not a twist in the bridle cables. (fig 11 shows an INCORRECT configuration).

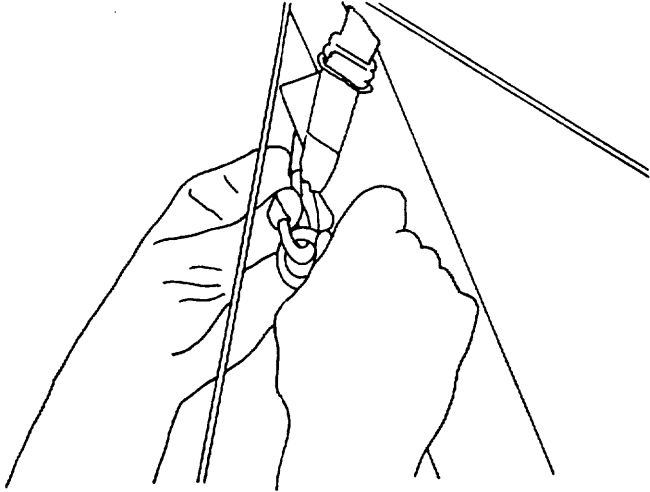

Fig 10

Wrong!

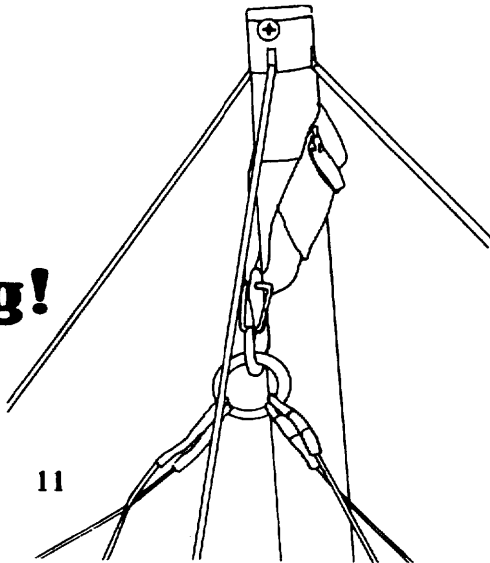

Fig 11

8) Attach the rear kingpost tang to the rearward most bolt on the keel. (Fig 12) Be sure that the tang slides all the way forward on the bolt, and be sure to attach the safety.

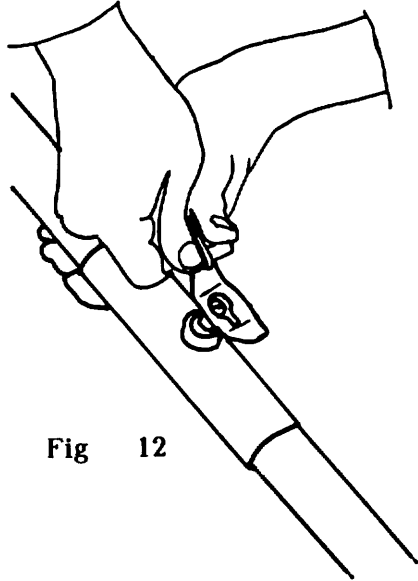

Fig 12

Make sure that the top rear cable passes over and behind all the bridle cables (fig 13) and that it is not looped under any bridle cable (fig 14 shows an INCORRECT configuration).

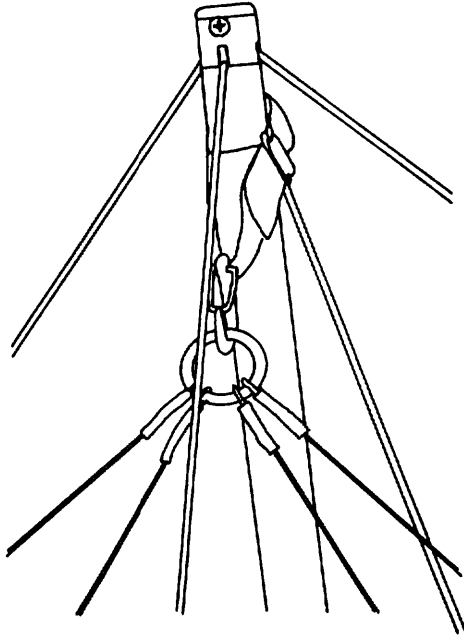

Fig 13

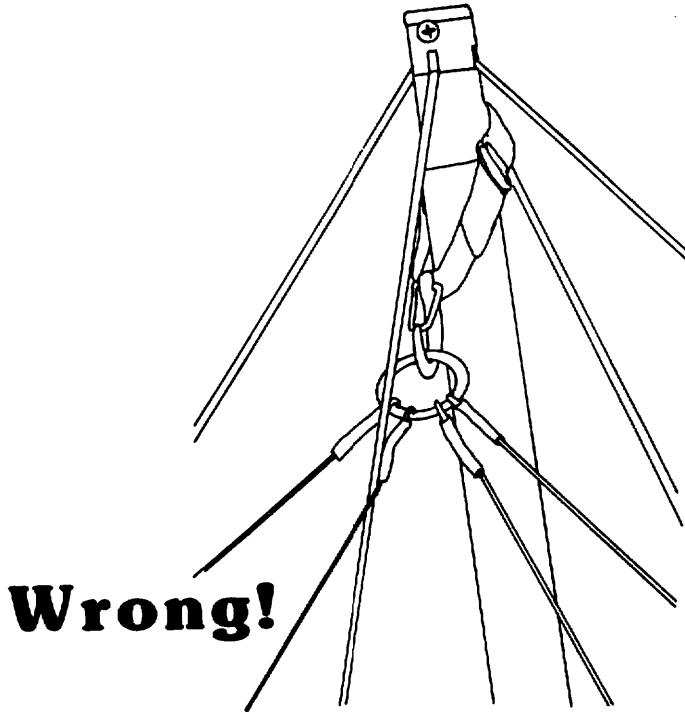

Fig 14

9) Install the washout tips, pushing them into the protruding sleeves until they come up against the clevis pin securing the sleeves in the leading edges. Then rotate the washout tips until you feel them lock into place. (Fig 15) Note: Installation of the washout tips is much easier if done now, before the battens are installed. You may have to pull the washout tip back out slightly to allow the spring button to drop completely into the hole.

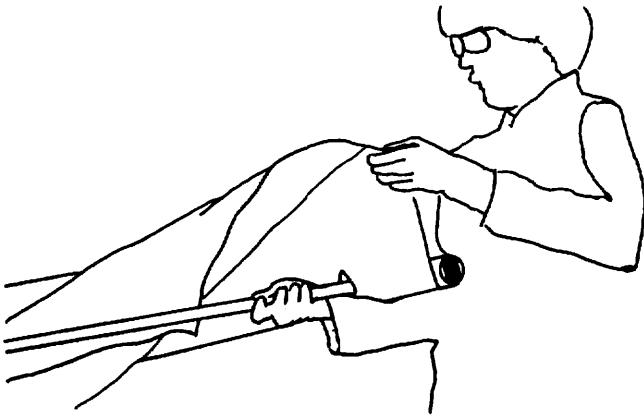

Fig 15

10) Remove the battens from the bag, lay them on the ground, and check them for symmetry, side to side. (Fig 16) Correct any that are asymmetric. (See the tuning and maintenance sections of this manual for more information on batten shaping.) Separate the right side battens (those with black tips) from the left side battens (white). Insert the top surface battens into the sail. Order of battens is longest to shortest from the root out to the tip. Wills Wing numbers battens from the tip inboard, so that the shortest batten (which is the straight plug on batten), is the number one batten, and the longest batten is the #8 batten. When inserting the number 8 battens, you should lift the rear end of the keel and hold it up so that the batten slides in more easily without the rear end scraping the ground. (Fig 17)

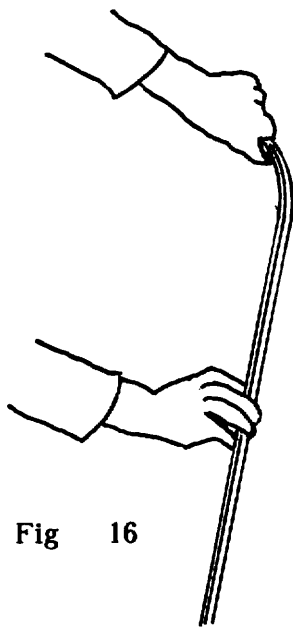

Fig 16

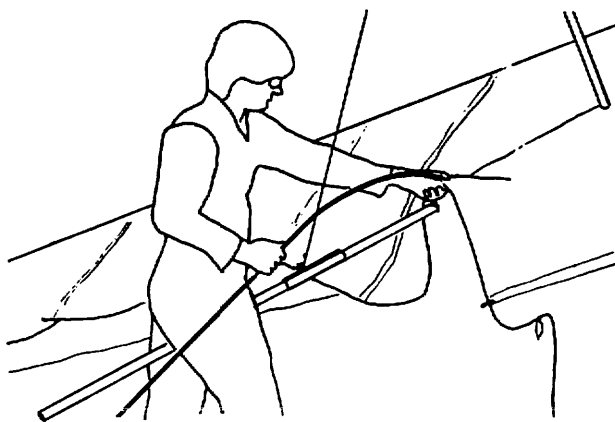

Fig 17

11) Secure the rear end of each top surface batten by first looping one loop of leech line around the notched batten end, and then attaching the second loop, using the extra loop as a handle. (Fig 18) When attaching the leech line loops at the reflex bridle battens, be sure the bridle cable is not caught underneath or wrapped around the leech line.

NOTE: The top surface battens must be installed before the crossbar is tensioned. otherwise you will decamber the battens and may ruin the sail. When inserting top surface battens, avoid allowing the batten tip to ride hard against the stitching on the side of the pocket. Batten pocket life will be greatly prolonged if you regularly spray your battens with spray silicone lubricant prior to installation. You may also spray the silicone into the end of the batten pocket, and the batten will distribute it along the length of the pocket.

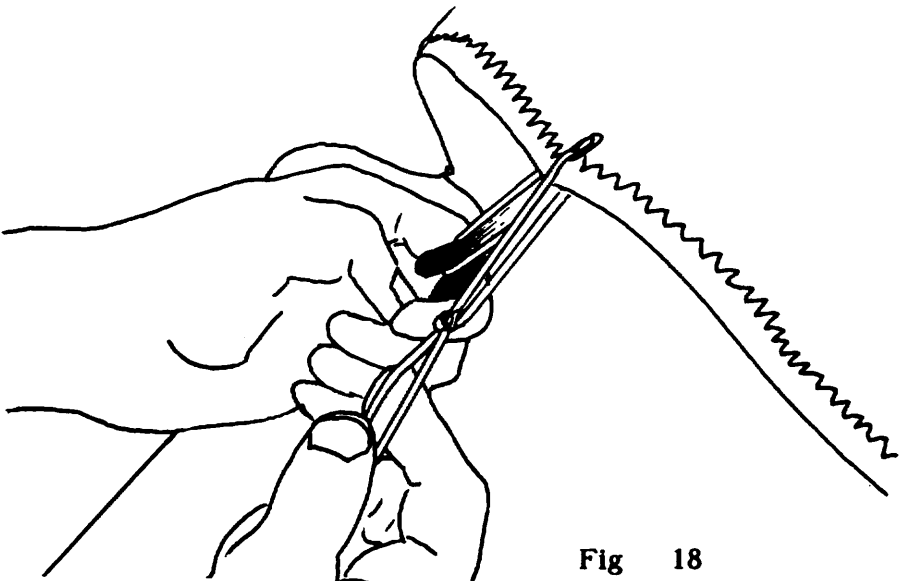

Fig 18

12) Spread the wings all the way and check all wires for twisted thimbles or tangs. (Fig 19 and 20)

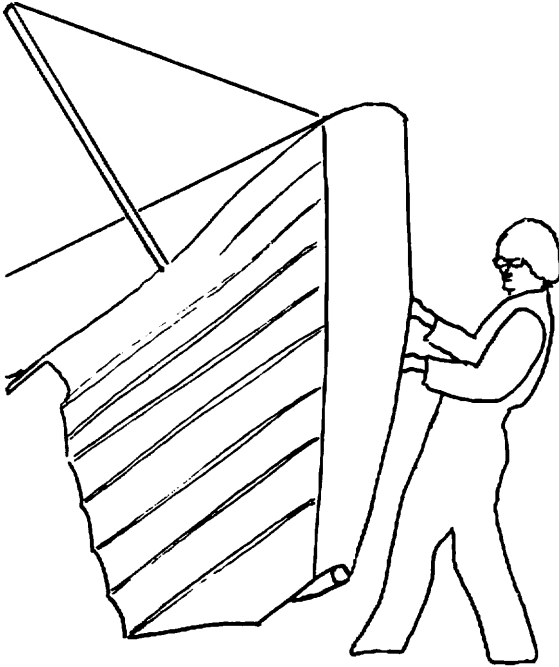

Fig 19

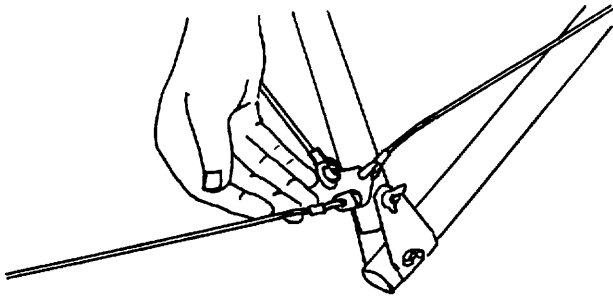

Fig 20

13) Remove the wingnut and safety from the bolt which is secured to the crossbar sweep wires. (The wires attached to the crossbar center.) Insert the free end of the piece of leech line which is attached to the control bar top through the thimble in the shortest of the two wires which make up the left (on your right as you face the rear of the glider) crossbar sweep wire. (Fig 21) Then pass the end of the leech line around the post on the black plastic loop cleat that is secured to the line near the top of the control bar leg. (fig 22)

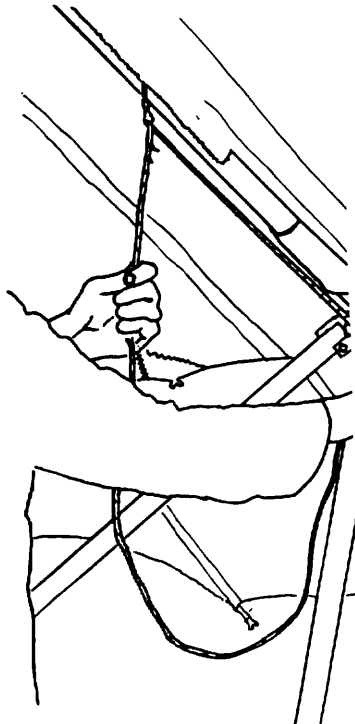

Fig 21

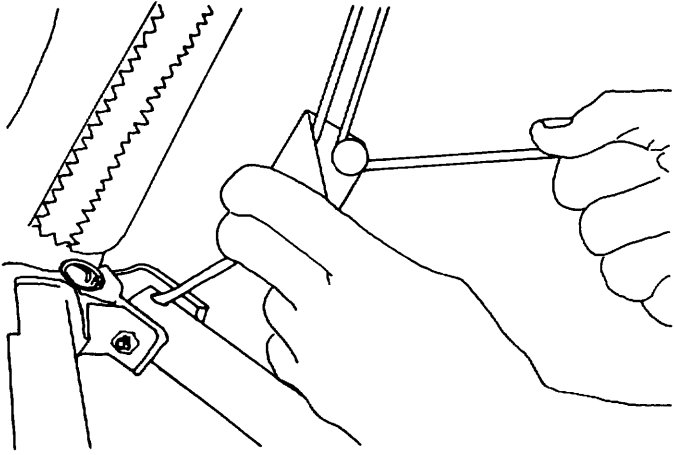

Fig 22

14) Finally, pass the free end of the leech line through the thimble in the crossbar wire a second time, in the same direction as the first time, and pull the leech line tight. (Fig 23).

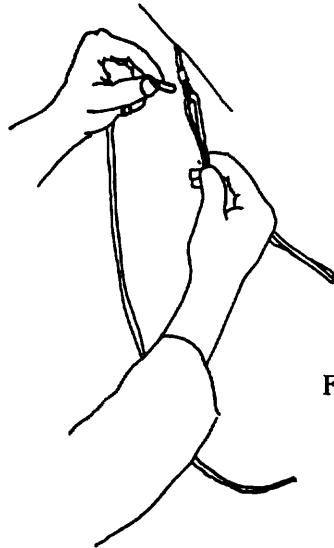

Fig 23

15) Wrap the leech line around your right hand, and push on the line with your left hand while pulling down with your right. (fig 24) This will allow you to pull the crossbar center back until the side wire loop becomes tight. Insert the straight tensioned portion of the leech line into the channel in the the black plastic loop cleat, and allow the cleat to capture the line. Insert the bolt through the hole in the keel,

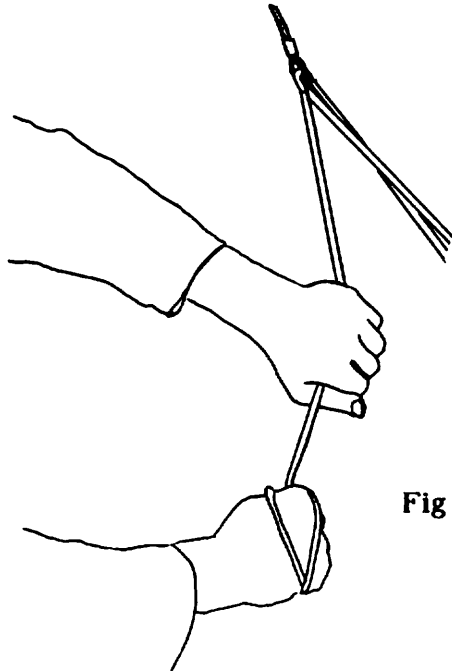

Fig 24

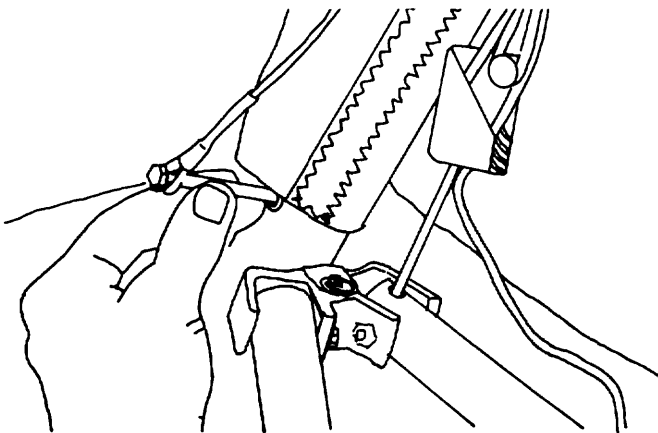

Fig 25

install the other side of the wire, and secure the assembly with the wing nut and safety. (Fig 25, 26, and 27)

CAUTION: Be sure to de-tension the leech line from the plastic loop cleat, and allow the crossbar center to ride forward until it hangs from the crossbar restraint cables. Otherwise the crossbar will be pulled too far aft, and the glider's flight characteristics will be compromised.

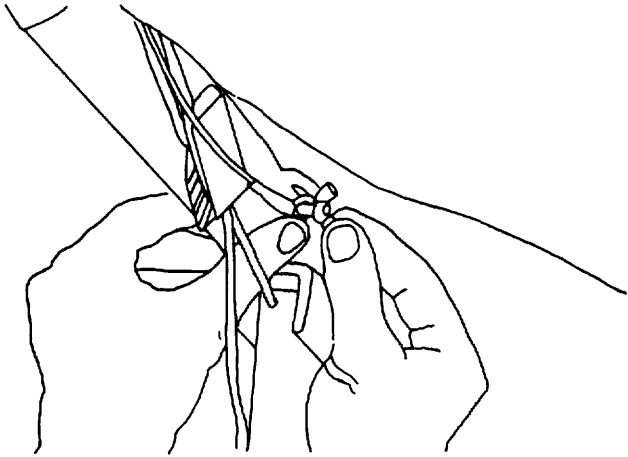

Fig 26

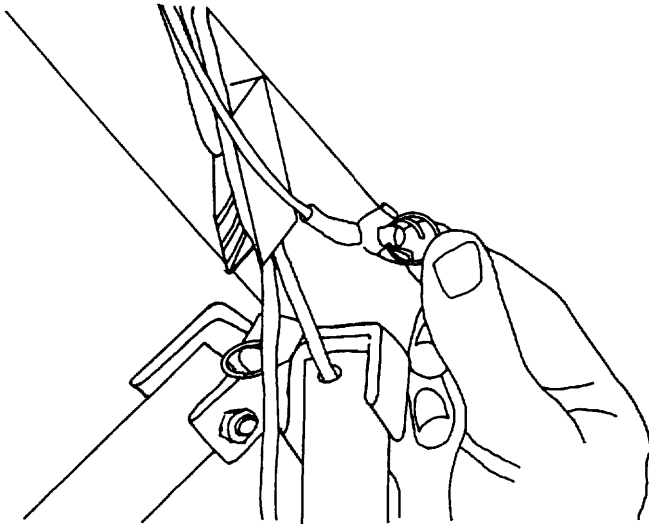

Fig 27

16) Attach the bottom front wires at the nose using the following procedure: First, be sure that the glider is sitting as level as possible, that neither wing tip is resting hard on the ground, and that the control bar base is pulled all the way forward so as to tension the bottom rear wires and put the rear of the keel on the ground. Lift the keyhole tang to the head of the bolt on the bottom of the keel. Press upward on the tang while pulling down on the nose of the glider (Fig 28), and the tang will slide over the bolt and pop into place. Note: Do not try to use the "T" handle on the tang for installing the tang, it is used only for removing the tang. Press instead on the tang itself on either side of the hole. Attach the rubber safety.

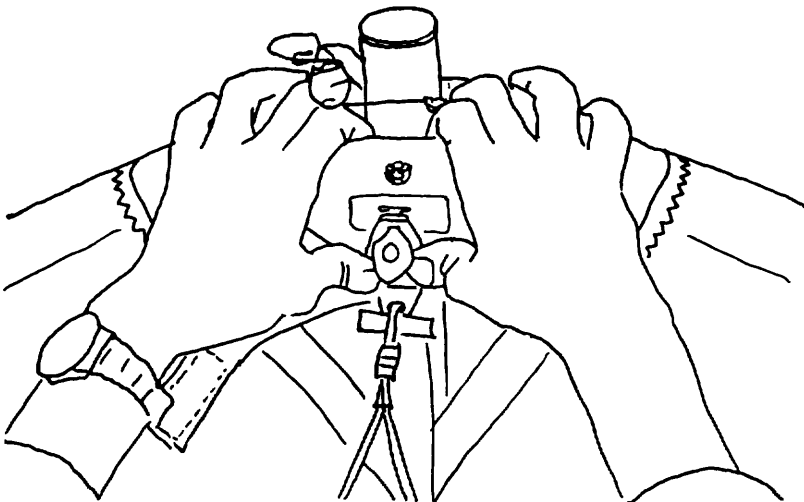

Fig 28

17) Install the bottom surface battens. If the wind is less than 10 mph, this is done most easily by putting the nose down (into the wind.) (Fig 29) The longer bottom surface batten is the inboard batten. When the front of the batten reaches the leading edge seam, you may have to press upward on the batten in order to allow it to clear the seam. Push the batten all the way into the pocket until the rear end is flush with the rear of the pocket. The strings on the rear ends of the bottom surface battens are to facilitate removal of the battens from the sail during beakdown. The bottom surface battens are not secured in the sail. Be sure that the battens go under the leading edge tube, and do not rest on top.

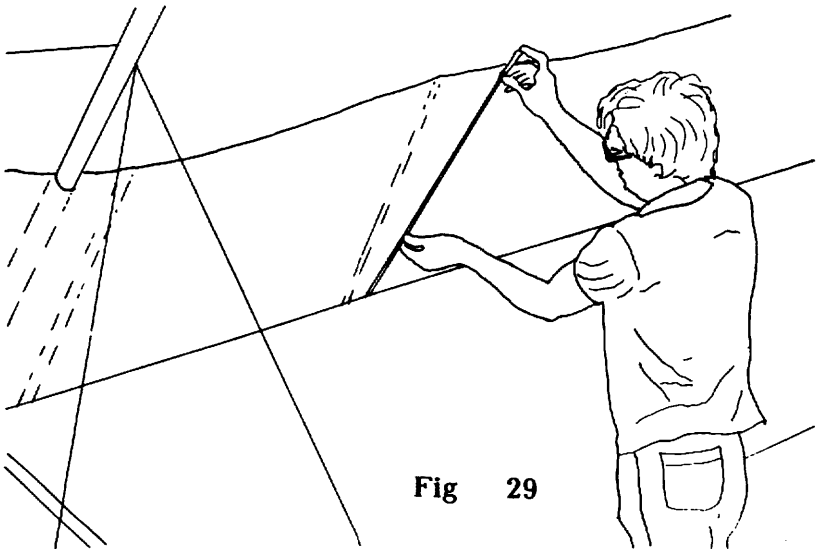

Fig 29

18) Insert the number one battens. They are inserted between the top and bottom surface through the gap in the seam. (Fig 30) They are not inserted through the washout tube hole. Fit the batten end fork on the front of the batten to the stud on top of the leading edge. (fig 31) Attach the leech line twice to each batten. You may find it easiest to sit on the ground and place your foot against the leading edge in order to obtain the necessary tension on the batten string. (Fig 32)

19) Set the glider nose into the wind, and pull the nose down. Grasp the string loop at the front of the nose batten and pull the forked batten end up and over until it sits on top of the keel tube. (Fig 33 and 34)

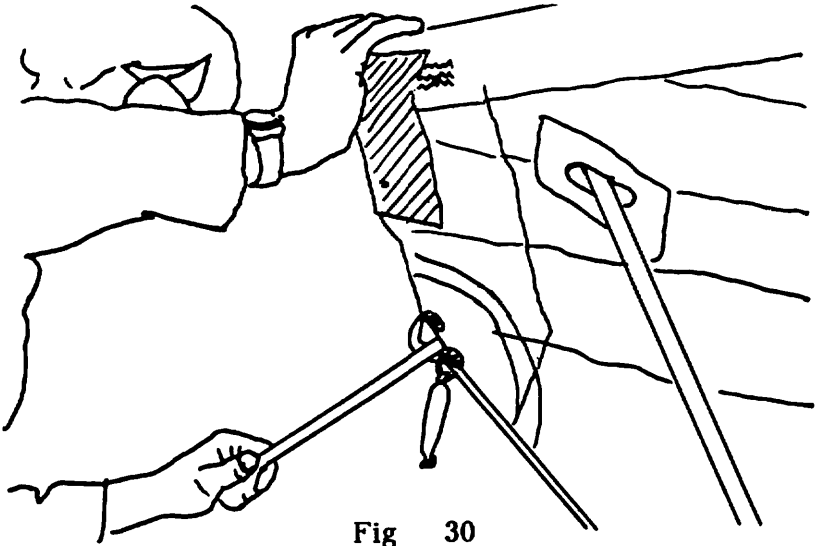

Fig 30

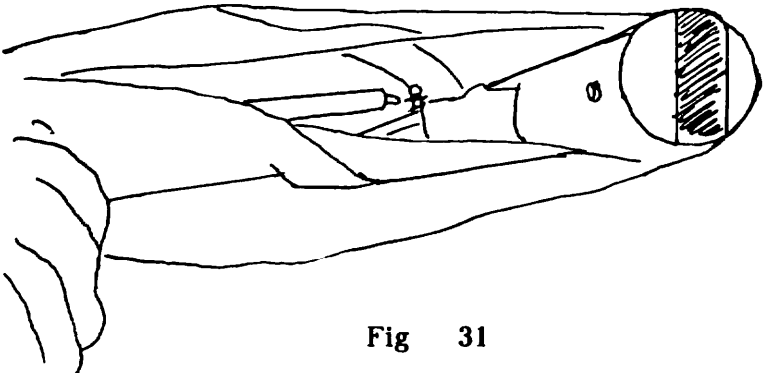

Fig 31

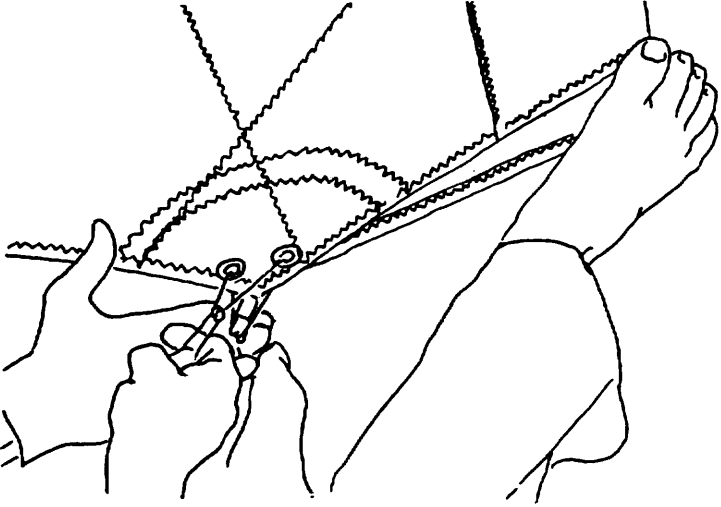

Fig 32

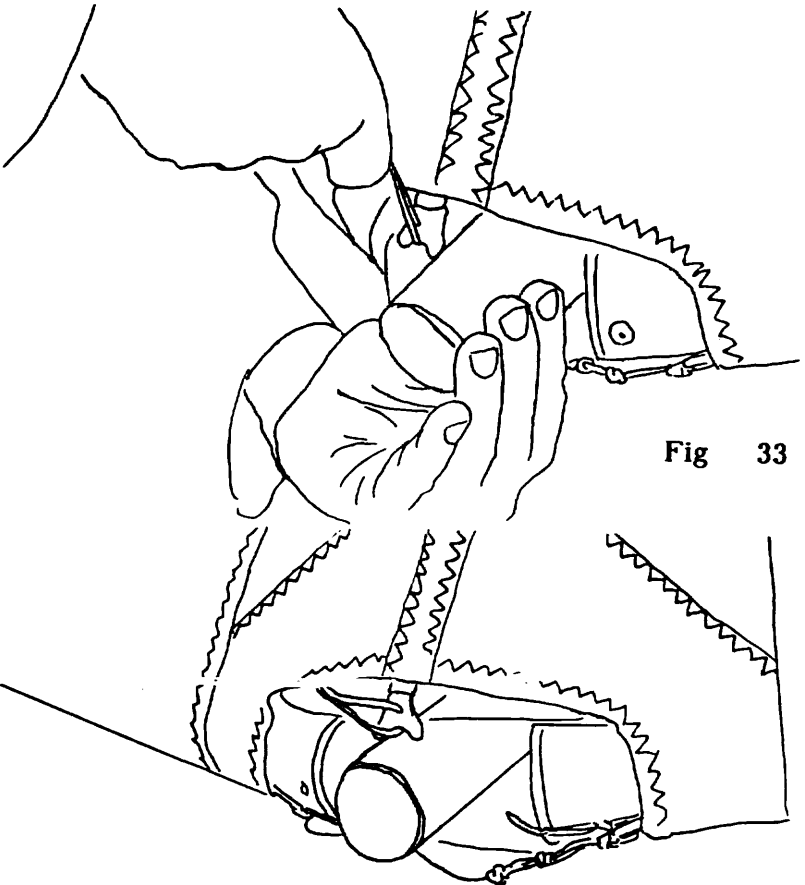

Fig 33

Fig 34

20) Do a complete walk around preflight of the glider. It is your responsibility during this preflight to check every part, component and assembly on the glider.

Beginning at the nose, check the nuts on all the nose bolts, including the safety ring on the top of the rear nose bolt. (Fig 35)

While at the nose, lift up on the edge of the sail above the noseplate and look down each leading edge. (Fig 36) Check for safety rings at the crossbar leading edge junctions. Check that all bottom surface battens are underneath the leading edge tube. Check for any evidence of dents in the leading edges, or bends in the tubes (look for signs of crystallization of the material; a brighter, fuzzy spot on the aluminum. Note: Some crystallization is normal at points on the tube where bushings have been installed. Of particular concern would be crystallization at the ends of leading edge sleeve, as this would indicate that the leading edge had been stressed to near the failure point.)

21) Continue the preflight at the control bar apex. Check that the nuts which secure the control bar top bolts are secure. (Fig 37)

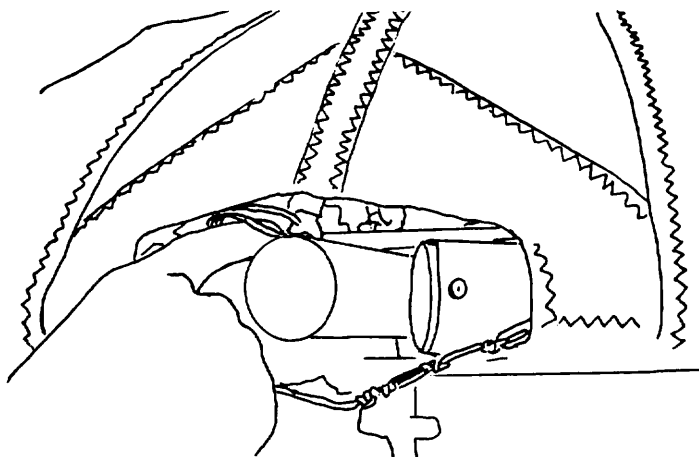

Fig 35

You may notice a downward bow of 2 inches in the keel tube. This is normal and intentional; the keel is not bent but bowed by the relatively shorter bottom front to rear wires, allowing it to lie within the double surface of the sail.



Fig 36

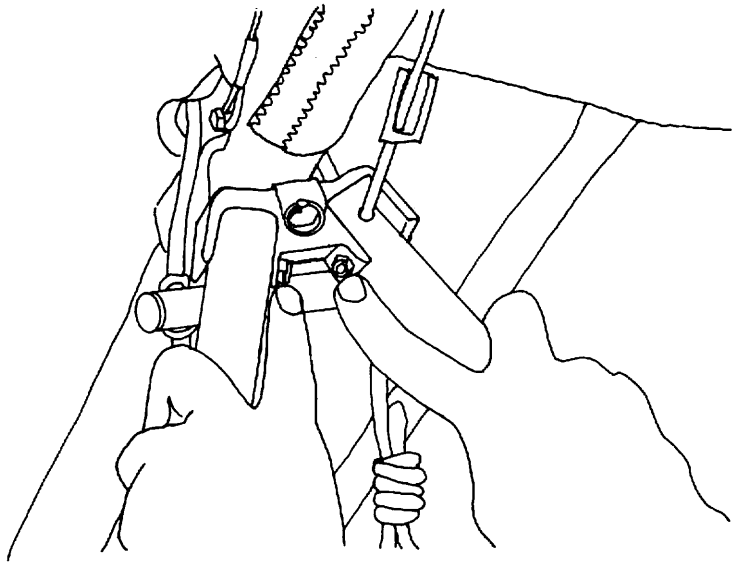

Fig 37

Check that the control bar top clevis pin and the safety on the clevis pin are in place, and that the pin is inserted from the rear so that the safety cannot be caught on the hang loop and pulled out. (Fig 38)

Check that the back up hang loop (1 3/4" sewn webbing loop) is properly secured in place and check the hang loop itself for signs of wear or broken stitching or improper sewing. (Fig 39 and 40)

Check the kingpost mounted main hang loop (knotted perlon loop) for wear at the kingpost junction, between the kingpost and the spreader bar, at the spreader bar, at the knots, and at the hang point. Check that the spreader bar is properly positioned just below the keel, (it will have been pulled down away from the keel during breakdown) and that it is aligned horizontally. Check that the perlon hang loop is adjusted so that it is three inches higher at the bottom than the back up hang loop. The perlon loop will stretch up to three inches under an eight G load, and, when adjusted properly, will transfer the load to the backup loop at that point. If the perlon loop is not at least three inches shorter than the back-up, you may find yourself hanging from the backup during normal flight maneuvers, which might reduce control authority.

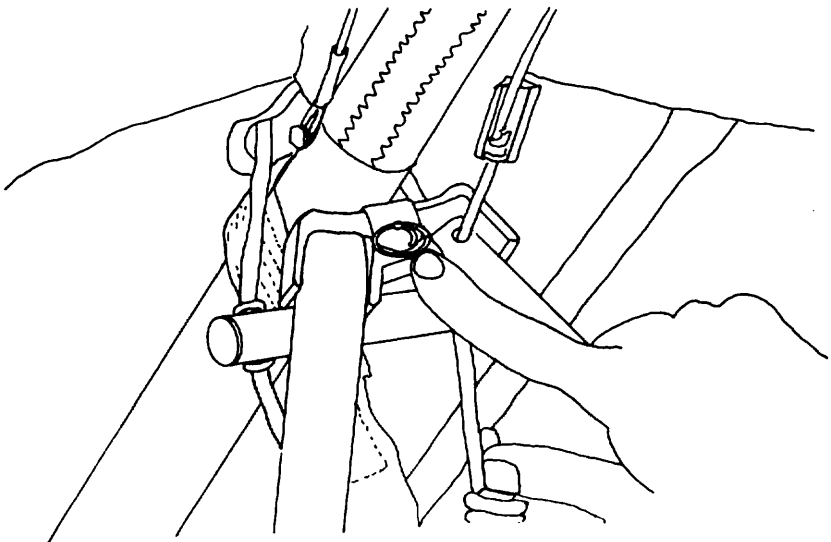

Fig 38

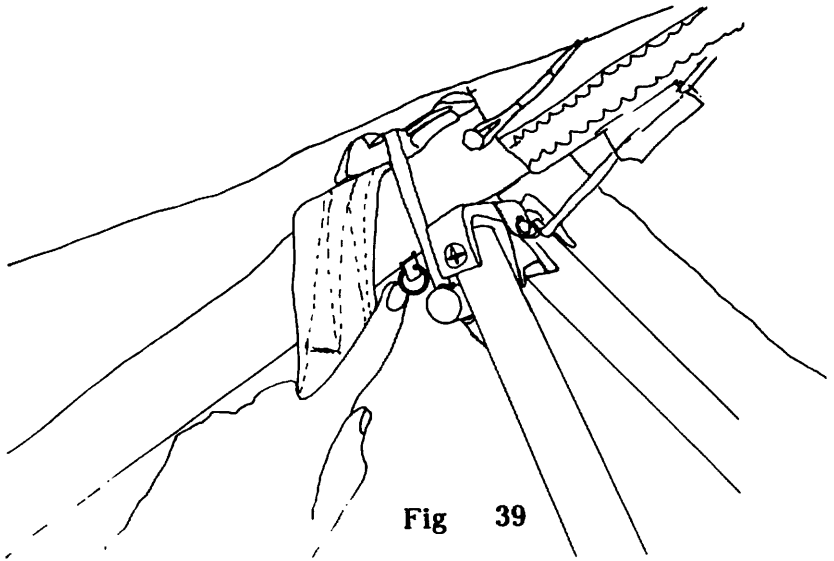

Fig 39

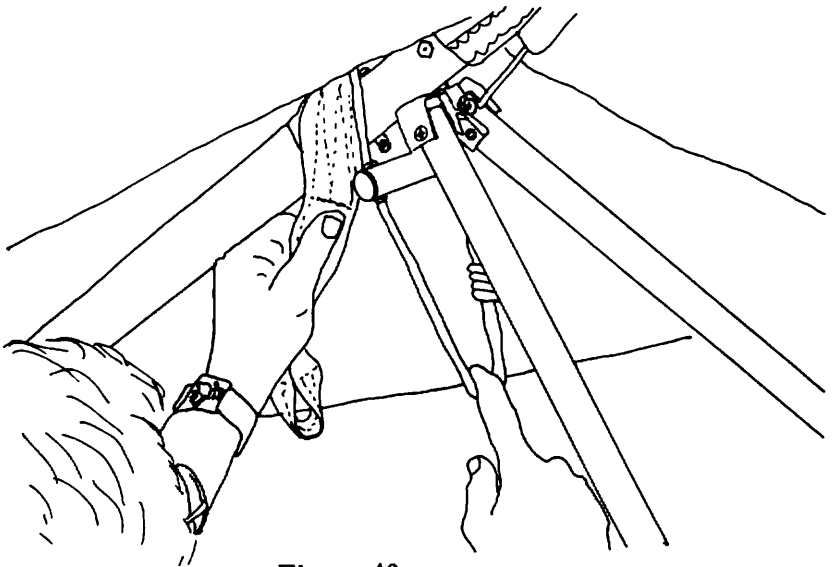

Fig 40

Never, never hook into the perlon loop without also hooking into the 1 3/4" back up loop. The perlon loop system has been tested to eight G's, and is rated for more than 16 G's, but it does not, in our opinion have an adequate safety factor if used as the only pilot support loop. The 1.75" backup loop is tested to 50 G's, and when properly maintained and used provides virtually absolute insurance against hang loop failure.

Check that the crossbar sweep wire tangs are aligned such that they pull straight back from the crossbar, and that the cables are not kinked and are under equal tension. Check that the safety ring is in place in the end of the crossbar center hinge bolt below the nut and tang. (Fig 41)

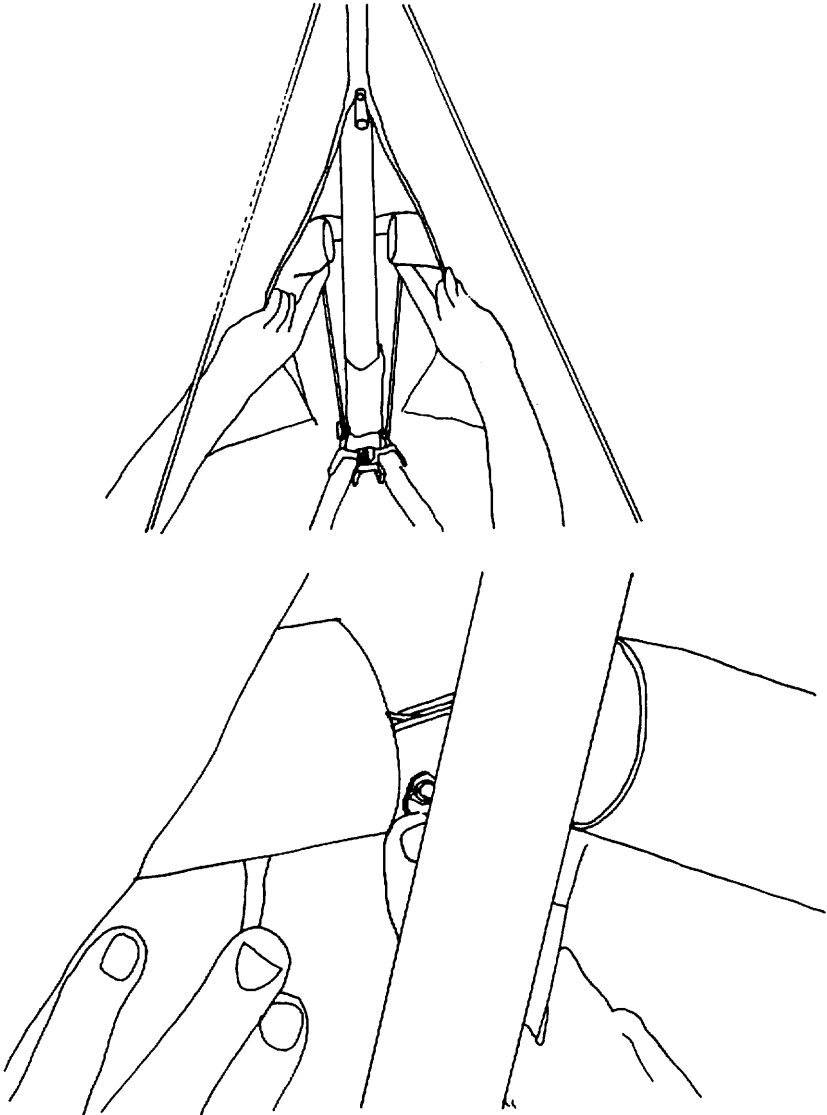

Fig 41

After your inspection in this area is complete, close the zipper by pulling the zipper slider all the way aft (Fig 42) Tuck the excess leech line into the bottom surface, and tension the center rear corners of the bottom surface and press the velcro together.

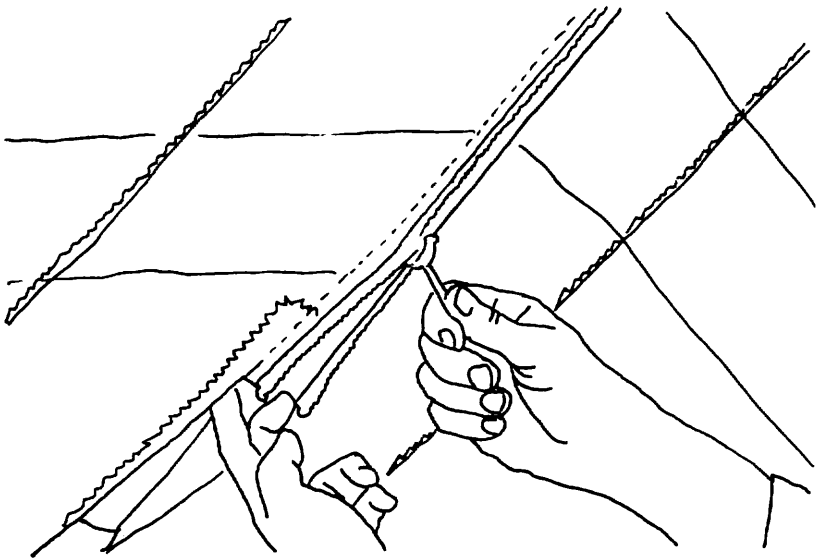

Fig 42

Sight down each downtube and check for bends or kinks. Do not fly with a bent or kinked downtube. (Fig 43)

Check the thimble fittings at the control bar corners for any cocked or twisted thimbles. If you find any, detension the crossbar and straighten them out. Prior to retensioning the crossbar check carefully for any kinks in the cable. If you kink a cable, you must replace it, or there is a danger it will fail after repeated loading and unloading.

Check the nylock nuts which secure the side wires to the control bar downtubes, and the nylock nuts, wingnuts and safety rings at the lower control bar corners. (Fig 44)

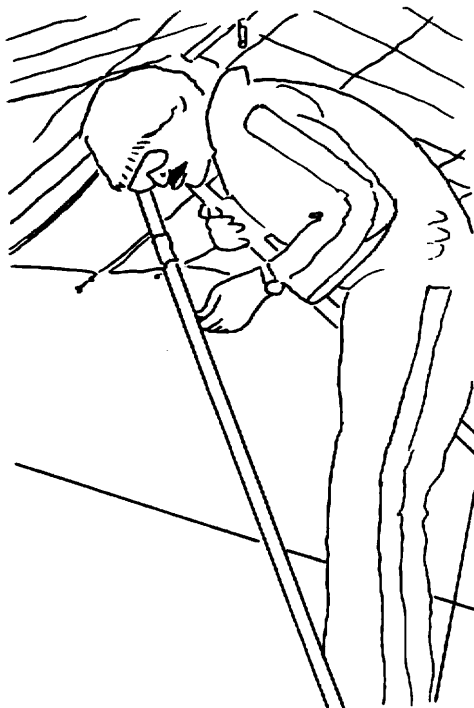

Fig 43

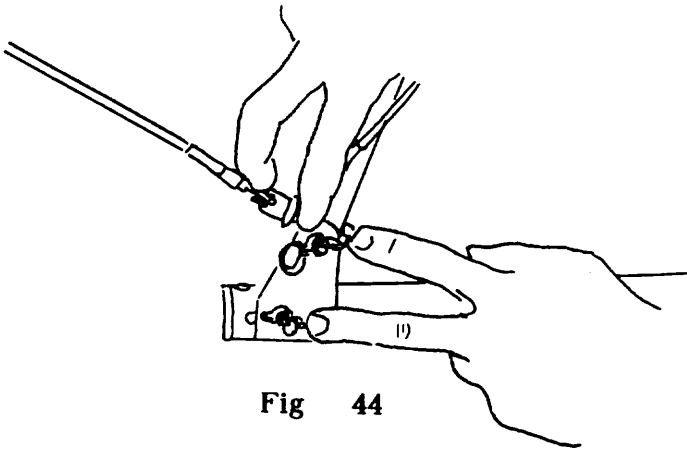

Fig 44

While pressing up on the leading edge, step on each bottom side wire with about 50 pounds of force. (Fig 45) This will test the side wire loop, and show up any fittings which are so loose as to be ready to fall apart, or any wires which are on the verge of breaking.

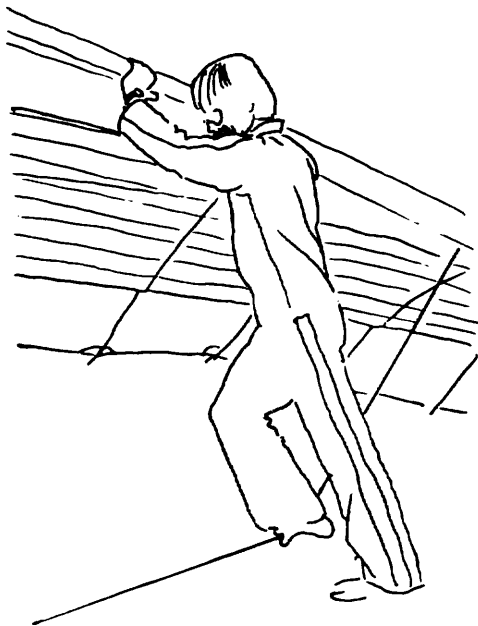

Fig 45

Check the trailing edge for any cuts, tears or broken stitching. (Fig 46) Check that all the battens are secured properly. (The illustration shows the number one battens). (Fig 47)

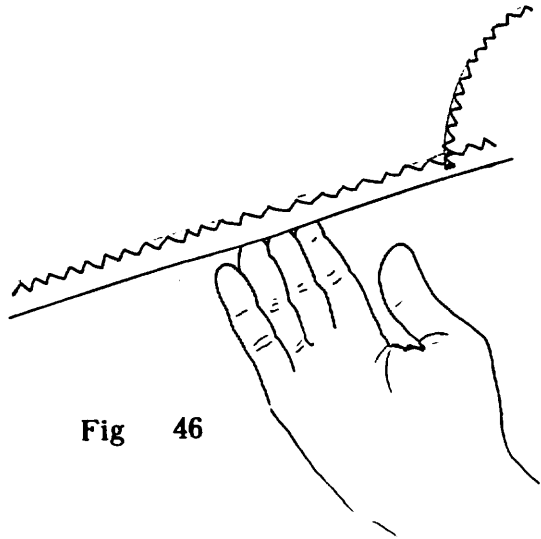

Fig 46

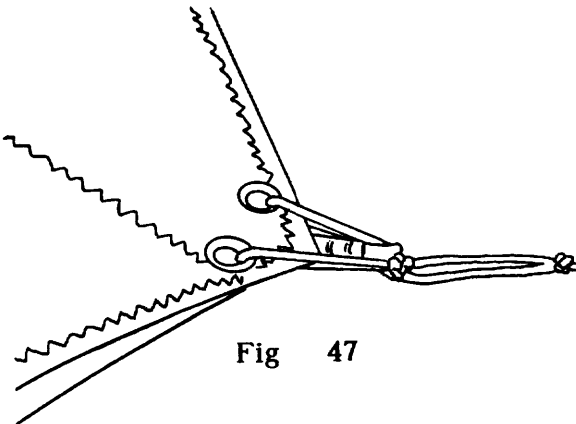

Fig 47

Look into the sail at each wing tip, and check that the number one battens are properly seated, and that the safety rings on top of the washout sleeve and number one anchor stud clevis pins are in place. (Fig 48)
Check that the sail mount plug anchor screw is in place, and that the twist in the plug is properly adjusted so as to provide equal tension to the top and bottom surfaces of the sail when the number one batten is held up about half an inch above the washout tube. (Fig 49)



Fig 48

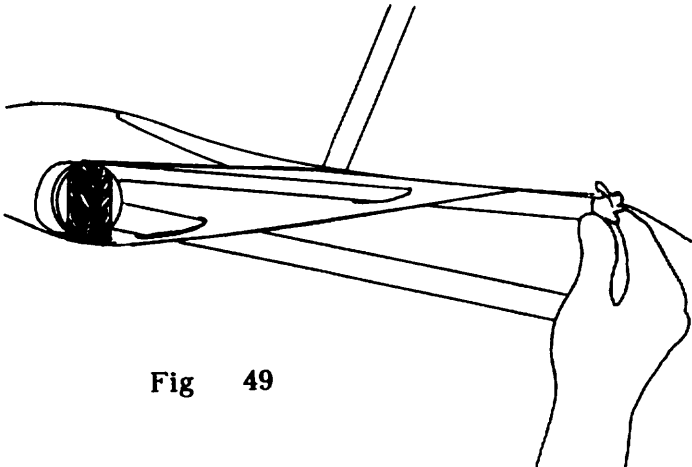
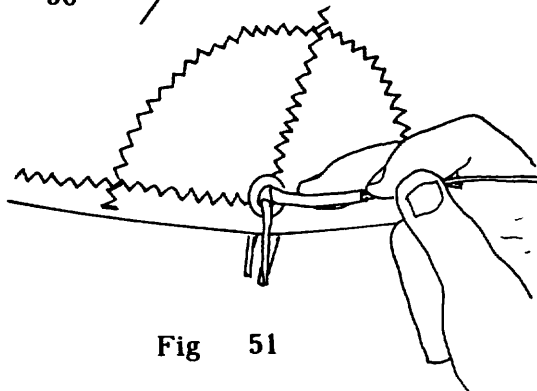
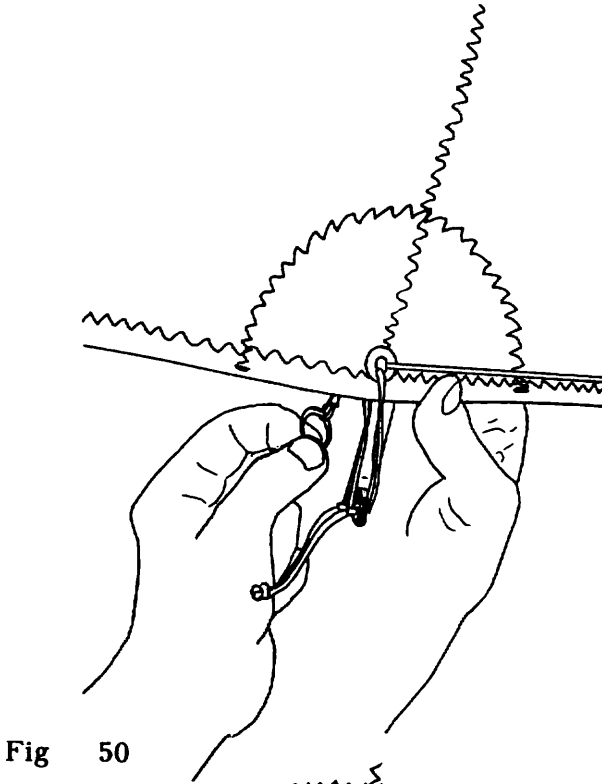

Fig 49

Check again that the top rear wire passes behind all of the bridle cables.

Check that each of the four bridle cables are free of the batten tension leech lines (Fig 50) and that the bridle cable key ring is flush with the bottom of the sail. (Fig 51)



Check that no bridle line is looped underneath a more inboard batten (Fig 52 shows the INCORRECT configuration).

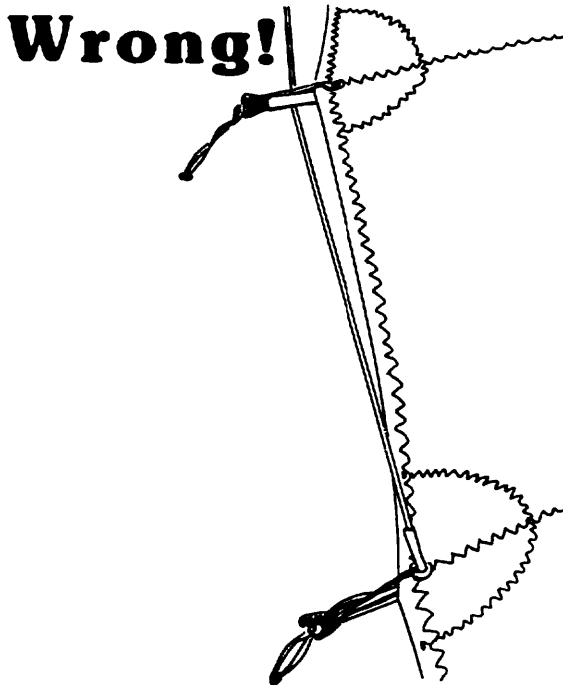

Fig 52

22) Fit the nose cone over the front of the keel (Fig 53) and attach the velcro at the top rear of the nose cone (Fig 54) taking care to line up the nose cone properly. Rest the glider back on its tail and pull the bottom corners of the nose cone back until the nose cone is tight around the nose (Fig 55) and secure the velcro on the bottom of the nose cone.

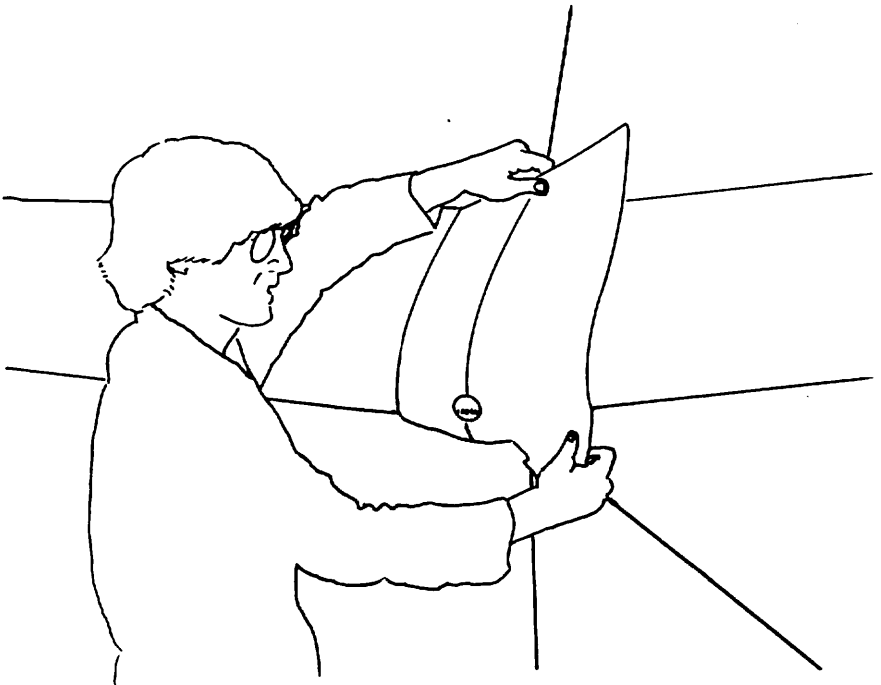

Fig 53

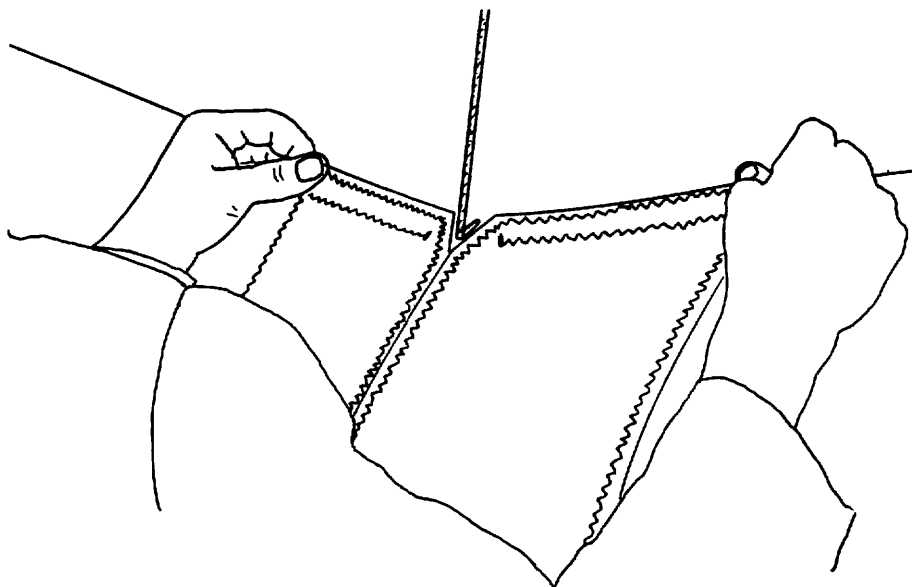

Fig 54

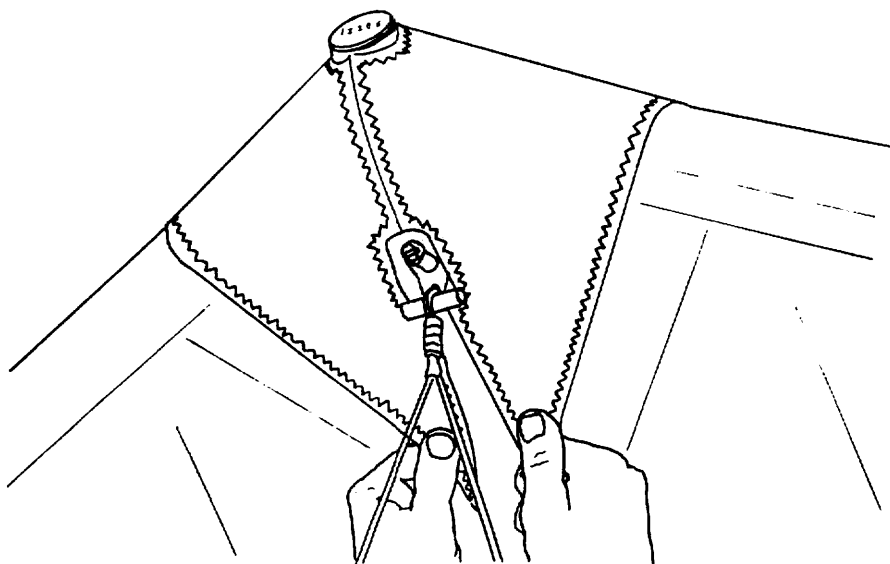

Fig 55

LAYING THE GLIDER FLAT

Once you have the glider set up, you can easily lay it flat on the ground: If there is more than ten miles per hour of wind, however, you should have assistance to do it.

1) Remove the safety from the front bottom nose bolt. Place your thumbs against the "T" handle on the keyhole tang and push up on this handle while pulling down on top of the nose as shown. (Fig 56) This provides the easiest method for removing the keyhole tang from the nose bolt.

2) Remove the clevis pin safety ring and then remove the clevis pin from the control bar "U" channel. Unthread the leech line from the plastic loop cleat.

3) Lifting the keel, pull the top of the control bar sideways out of the "U" channel, and lay the control bar down.

4) Lay the glider flat on the ground CAUTION: Be sure to have the nose pointed into the wind when using this procedure and be gentle when laying the glider down and lifting it back up, otherwise you may bend or break the keel.

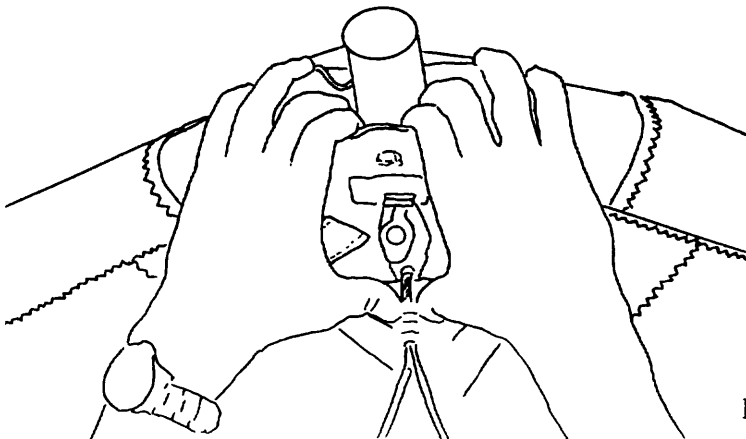

Fig 56

LAUNCHING THE SPORT

The SPORT has a very slightly tail heavy static balance. When you hold the glider prior to your take off run, you should have the nose slightly elevated and the wings level. If the wind is more than ten mph or is gusty, you should have at least one wire assistant, on the nose wires. Make sure all signals are clearly understood beforehand. Make sure all spectators are clear. Make sure you are hooked in and check your position hanging in the control bar.

Give a good aggressive run and ease the bar out for lift-off.

Have a good one!

FLYING THE SPORT

The SPORT has flight characteristics which are typical of a high performance flex wing, although you will find the handling characteristics of the SPORT to be superior to most, if not all gliders in its performance class. Some of the SPORT's handling characteristics may be unfamiliar to you, depending on what gliders you are used to flying. Make your first flights from a familiar site in mellow conditions. Give yourself an extra margin of safety in all maneuvers until you are thoroughly familiar with the glider's response characteristics.

HANG POSITION

We strongly recommend that you hang as low as possible (as close to the basetube) in the SPORT for maximum ease of roll control. The higher you hang off the bar, the shorter your pendulum is, and the higher will be the roll bar pressures. Also, hanging higher makes the lateral component of the force you exert with your arms

smaller, and forces you to work harder to achieve the same weight shift. If you are used to hanging fairly high off the bar, you will probably find it uncomfortable at first to hang lower. From our experience, however, you can get used to hanging lower in a relatively short time, and you will be rewarded with substantially better control authority. Make sure that your parachute is secure in your harness, and that it is not in danger of snagging on the basetube.

NOTE: If you need to lengthen your hang loop system to lower yourself, we strongly recommend that you use a new perlon main loop, and a new back-up loop of the proper length, (3" longer than the final adjusted length of the perlon loop) and have them installed by your dealer. It may be unsafe to extend the length of the hang loop system by adding additional loops.

TURNING IN SMOOTH AIR AND LIGHT LIFT

When flying in smooth air with weak areas of lift, you can cruise at minimum sink and initiate turns by pushing straight to the side on the control bar. Minimum sink is achieved with the control basetube (straight basetube) between your chin and your eyes. As the glider begins to turn, relax pressure and allow yourself to move back to the center of the bar. This will allow for slow, flat turns without overbanking or the need to high side the bar.

TURNING IN MODERATE TO STRONG THERMAL LIFT AND TURBULENCE

When flying in stronger lift, you should cruise at a high minimum sink or low best L/D speed, with the (straight) basetube between your chin and your chest. Avoid the temptation to pull in prior to moving to the side when initiating a turn, unless you are flying too slowly to begin with.

SPEED TO FLY

Most hang gliders obtain minimum sink rate performance at or near their lowest controllable airspeed. The SPORT is controllable at speeds well below that of minimum sink. If you fly as slow as you can while still retaining some lateral control, you will be flying in a partial stall, and you will not be getting your best sink rate.

THERMALLING THE SPORT

Proper airspeed control when thermalling is important in order to obtain optimum climb performance on the SPORT. If you fly your turns too fast, you won't climb as fast as you could because the higher flying speed will increase your sink rate and your minimum turn radius. On the other hand, if you fly too slow in a thermal, you may end up flying around with one wing continuously stalled. This also will hurt your sink rate. The SPORT does tend to track well and seek an appropriate airspeed while thermalling, and is thus easier to fly in this mode than most other gliders.

LANDING THE SPORT

Landing should start with a long straight final approach at faster than best L/D airspeed, straight into the wind. Fly the glider right down to ground level at this speed, keeping the wings level, and maintaining a heading straight into the wind. When you level out, your basket should be no more than two or three feet off the ground, and your feet should be drawn up slightly behind you. Expect the SPORT to fly a long way in ground effect. Once you have attained this low altitude ground skim, ease the bar out as your speed drops off to maintain your altitude. As you lose speed, you will need to ease the bar out progressively faster to maintain your altitude. When you feel the pitch response become "mushy" and unresponsive, quickly push the bar all the way out. Do not fly the glider so far into the mush that your arms are extended and you have nothing left to flare with. Your hands should be positioned high on the downtubes for a good flare. If

you cannot hold the downtubes with your hands at shoulder width when your hands are at shoulder height, your harness leg straps are too long for an optimum flare capability. (Fig 57) Your body position prior to flare should be upright, inclined slightly forward, with your feet and legs trailing behind you. (Fig 58) If you try to hold your feet in front of you, it will prevent you from achieving an adequate flare. (Fig 59) When it is time to flare, flare aggressively, and hold the bar out. (Fig 60) With a good sharp final flare, the glider will quickly attain a very high angle of attack, and the sudden increase in drag will slow the glider very suddenly. You will then swing forward underneath the glider, your feet will come underneath you, and you will land on your feet with the glider settling nose up on your shoulders.

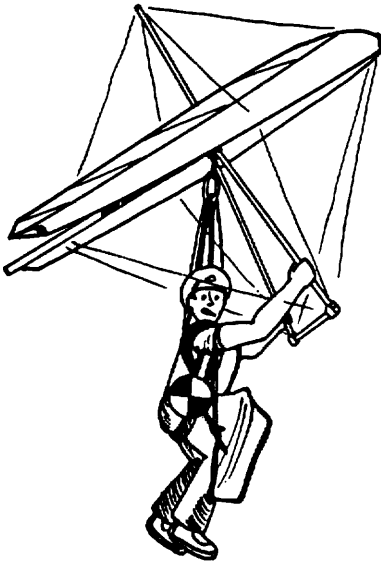

Fig 57

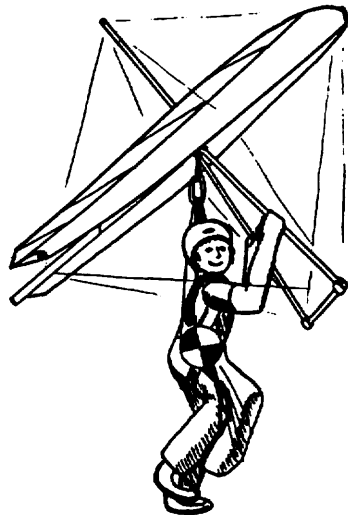

Fig 58

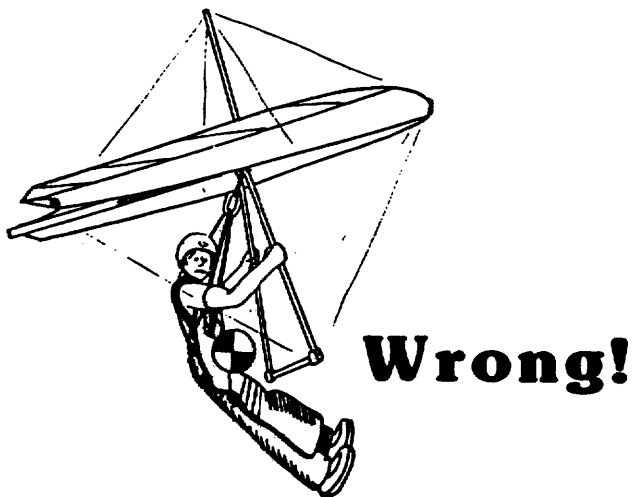

Fig 59

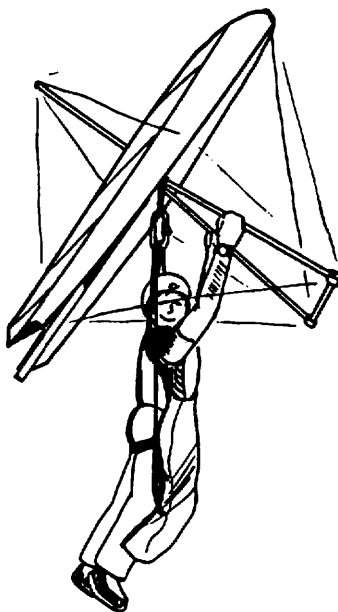

Fig 60

SPORT BREAKDOWN

Breakdown of the SPORT is simply the reverse of the set up procedure.

- 1) Do not remove the nose batten, but dismount the front end from the top of the keel and pull the batten out past the top noseplate.
- 2) Remove the bottom surface battens. Do not remove the top surface battens at this time! Remove the number one battens now, before you undo the crossbar.
- 3) Detach the bottom front wires at the noseplate by pressing upwards with your thumbs on the "T" handle while pulling down on the nose. (Fig 61)

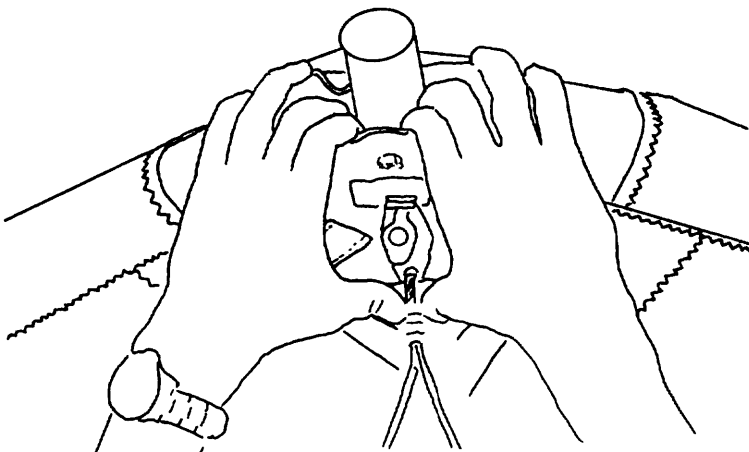
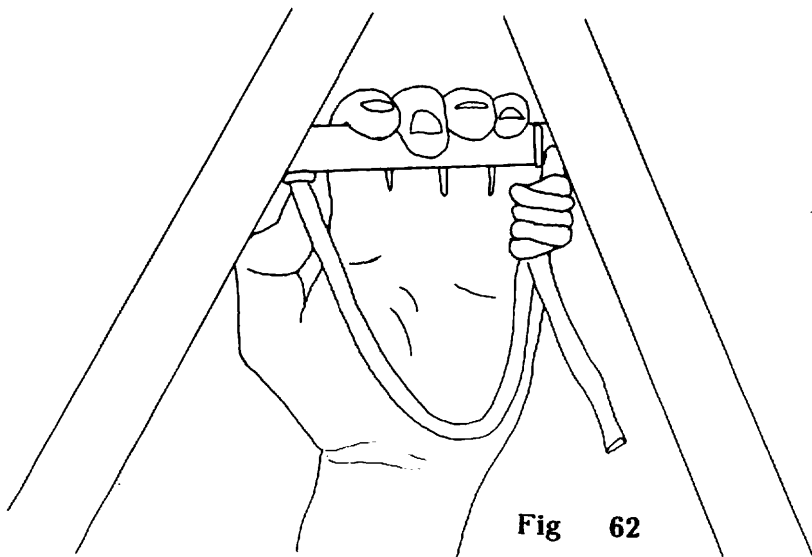

Fig 61

4) Unzip the bottom surface centerline zipper almost all the way. Tension the crossbar slightly with the leech line pull so that you can remove the anchor bolt. Reinstall the bolt through the thimble in the second cable with both cables and the bolt below the keel. Remove the leech line from the plastic loop cleat, so that it does not engage in the cleat as you pull the crossbar forward or fold the wings in. Pull the crossbar forward.

Pull down on the hang loop spreader bar until it hangs well below the keel. (Fig 62) This is to keep it from becoming pinched in between the leading edges or between the leading edge and keel when you fold the wings in.

NOTE: If the zipper is left closed when you fold the wings in, the sweep wire bolt can catch on the rear of the zipper and tear it loose from the sail.



5) Pull the wings in slightly and remove all the battens. Lift the keel as you remove the #8 battens.

6) Detach the top rear wire keyhole tang from the rear of the keel.

7) Detach the bridle ring from the snap hook. Remove the kingpost from the base by lifting straight up, and place the bridle ring over the kingpost base. (Fig 63)

Install the bungee attached rubber protective cover over the kingpost base.

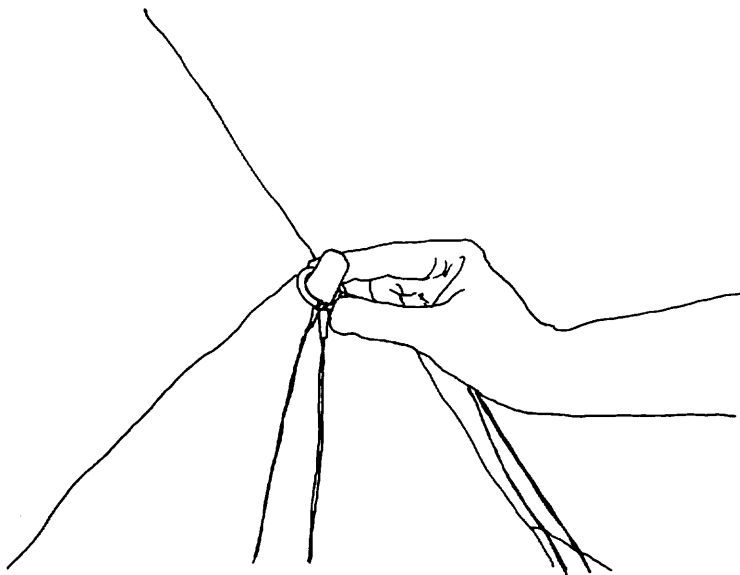

Fig 63

8) Remove the washout tips. Fold the wings in pulling the sail over the top of the leading edges. (Fig 64) If you meet resistance while folding the wings in, stop and check that the crossbar center section is not caught between the keel and front leading edge.

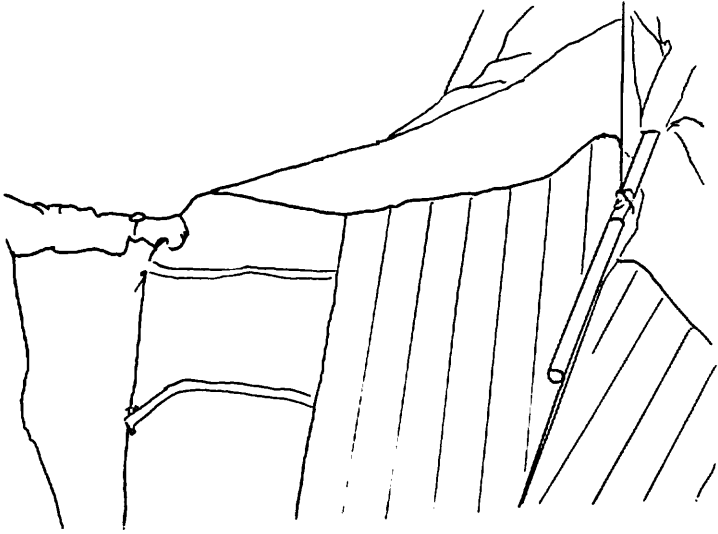

Fig 64

9) Pull the sail out so that both the top and bottom folds of the sail are equally taut, and roll the washout tips and lower surface battens up in the sail. (Fig 65)

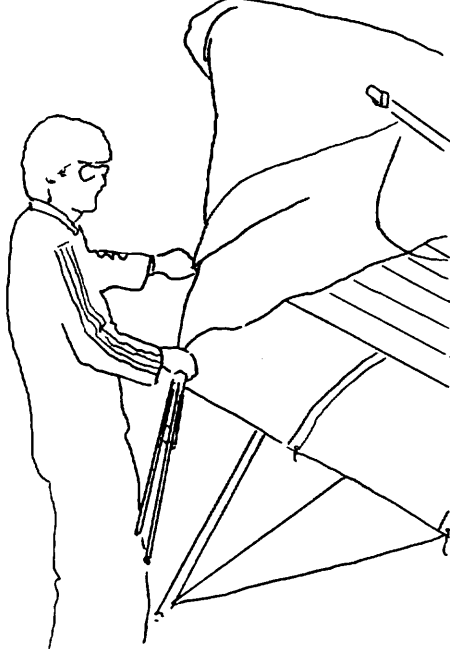

Fig 65

Do one side first, and pull the mylar pocket up and around the rolled sail (Fig 66) and secure it temporarily with one velcro strap.

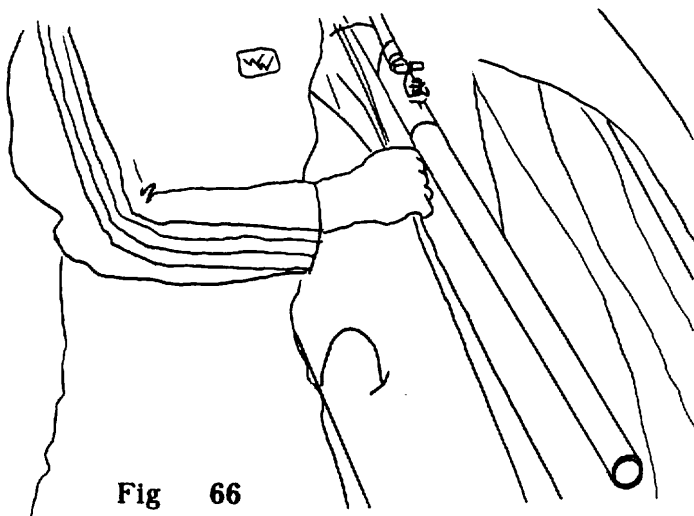

Fig 66

10) Roll the second side, and place one velcro strap OVER the keel and around each leading edge and rolled sail in the vicinity of the leading edge/crossbar

junction. (Fig 67) The mylar pocket from one side should be pulled underneath that of the other side, the mylar should sit on top of the leading edges, and lay smooth. Do not overtighten the velcro. (Fig 68) Secure the velcro strap that is attached to the front keel in a like manner, again pulling the mylar pocket on one side up and over the other side. Make sure this strap passes over the top of the keel and supports the leading edges above the control bar top "E" bracket. Make sure at this time that the hang loop spreader bar is free of and below the leading edges.

If the sail will not fold up cleanly it may be because the restraining string which mounts the sail to the nose is too loose.



Fig 67

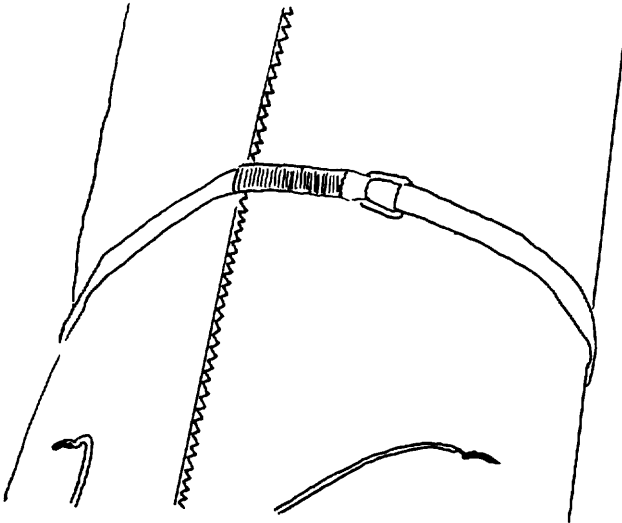

Fig 68

NOTE: If you roll up your sail wet, and leave it packed up wet, there is a good chance that the colored dyes in the cloth will bleed from the darker colors onto the lighter colors, staining the sail. There is also a chance of corrosion to your frame and wires. If you MUST roll up a wet sail, unroll it and dry it as soon as possible thereafter.

11) Place the last velcro around the sail near the rear end of the leading edges. Place the bag on the glider with the flag at the tail end. Install the protective rubber caps on the washout studs. (Fig 69) Lay the glider on the ground, disassemble the control bar and fold it rearwards. Align the spreader bar between the control bar downtubes as shown. (Fig 70)

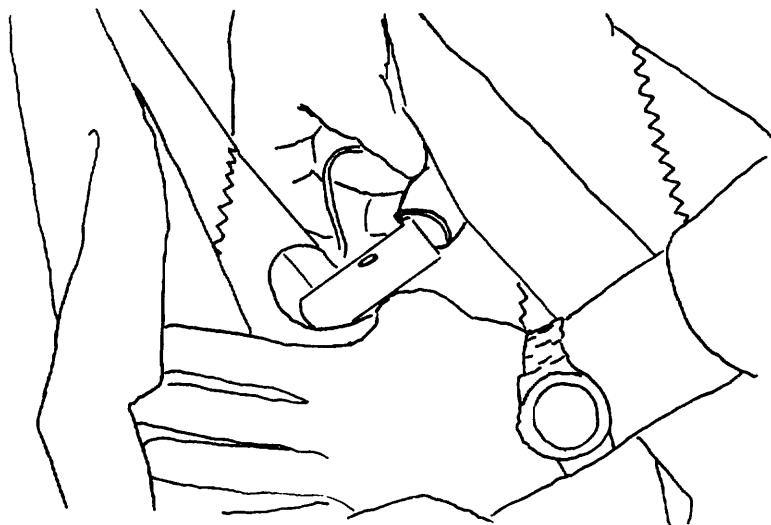

Fig 69

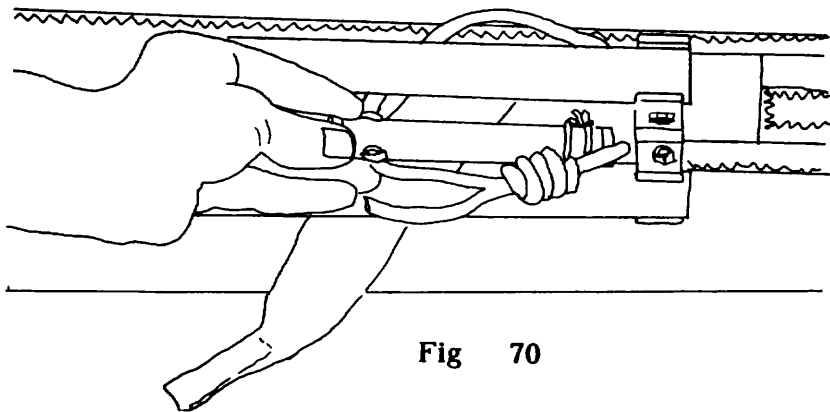

Fig 70

12) Insert the pad underneath the keel, (Fig 71) and between the keel and control bar and secure the velcro tabs. Install the protective bag over the rear end of the control bar. (Fig 72)

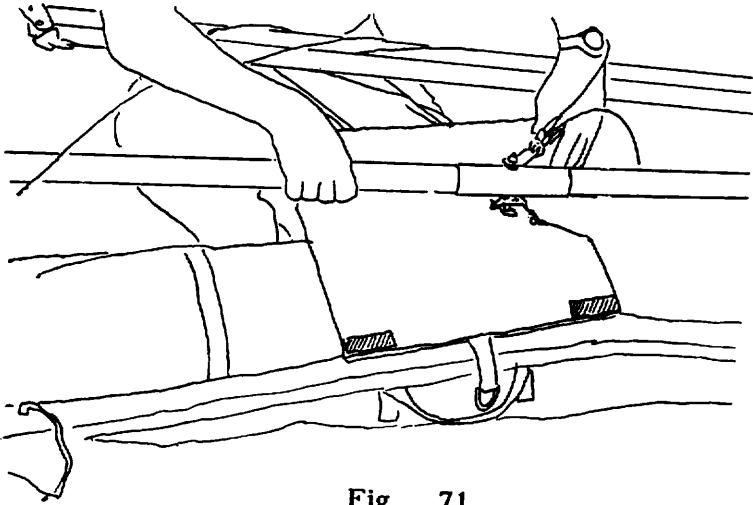

Fig 71

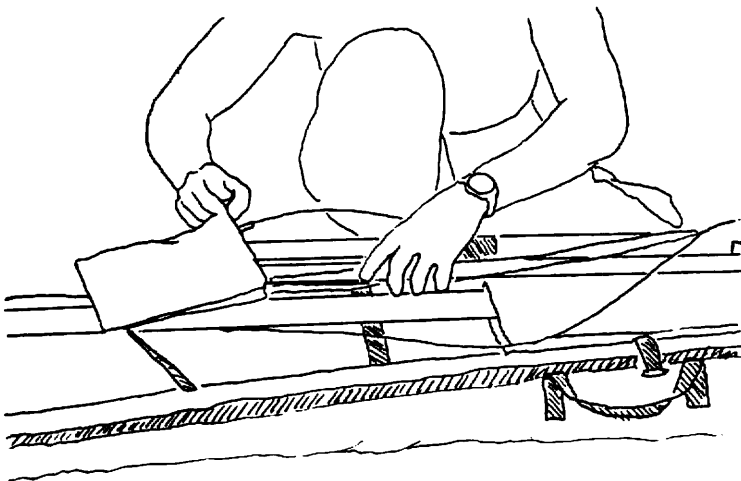

Fig 72

13) Secure the velcro strap around the control bar.
(Fig 73)

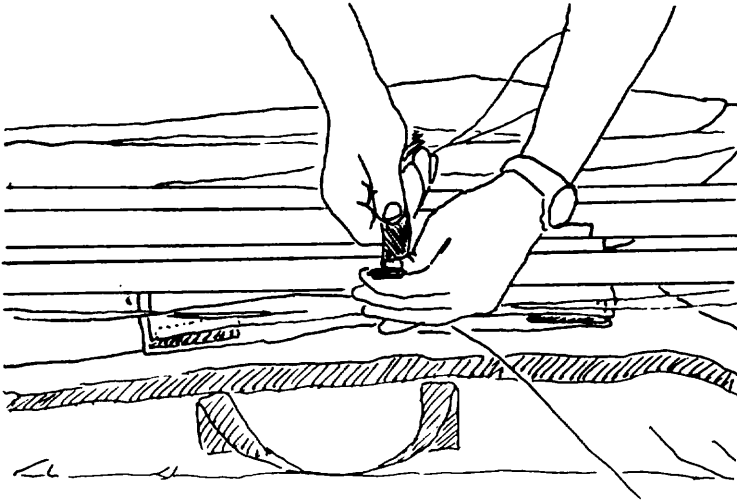

Fig 73

14) Place the battens together carefully and stow them in the batten bag. With the curved end towards the front, stow the battens between the rear leading edges of the glider. (Fig 74)

15) Slide the nose cone under the forward most velcro strap. (Fig 75) Zip up the bag.

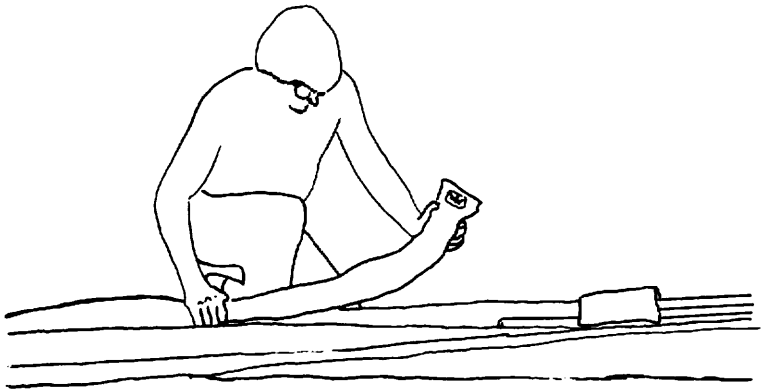

Fig 74

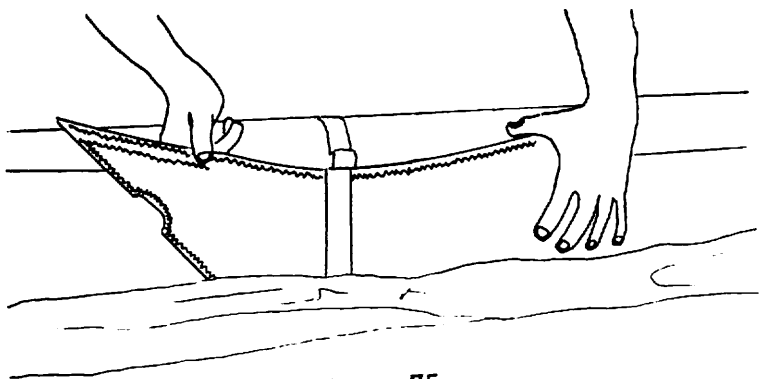

Fig 75

SPORT TUNING

In the following section, the various adjustments which can be made to tune the SPORT are summarized. Tuning a hang glider is an operation best performed by an expert pilot experienced with evaluating the effects of various adjustments on the glider's flight characteristics. If you feel qualified to tune your own glider, feel free to experiment with the various adjustments that are outlined in this manual. Prior to doing so, however, you should read carefully the detailed tuning information in the service section of this manual.

LEADING EDGE SAIL MOUNT TENSION

The sail tension along the leading edge affects turn trim, performance and handling characteristics. If the sail is mounted too loose, the glider will not perform as well as it should. If the sail is mounted too tight, the glider will be hard to turn and have a greater tendency to adverse yaw or spin. If the sail is mounted assymmetrically the glider will have a turn to one side. See the section on leading edge sail mount tension in the service section of this manual for a detailed explanation of how to adjust the leading edge sail tension.

BATTEN TRUING

You will need to periodically check your battens against the batten diagram provided. The batten diagram must be laid flat on a flat, smooth surface in order to get accurate results. Follow the instructions on the pattern for truing the battens. Improperly shaped battens may affect the glider's handling, turn trim, performance, and safety.

REFLEX SUPPORT BRIDLES

Proper and precise adjustment of your reflex support bridles is fundamental to your glider's control authority and response, its pitch stability, and its ability to resist being tumbled in turbulence. If your bridles are too loose, your glider will be less stable and possibly less resistant to tumbling, and therefore probably less safe. If your bridles are too tight your glider will offer inadequate pitch and roll control authority and response.

Bridle adjustment is checked by flying the glider and sighting the shadow of the bridles on the sail. This can most easily be done by doing shallow banked turns during the middle of the day. When the shadow of the bridles falls on the sail, shake the control bar sharply back and forth in pitch by six inches or so. Watch the shadow of the bridles on the sail. If you can see a curve of slackness in the bridle cable which swings more than two inches as you shake the bar, your bridles are probably too loose. You should shorten the bridle webbing strap so as to raise the bridle ring by 1/2", and then check the bridles again. If the bridles are so snug that the cables appear to be straight and under mild tension, and shaking the bar produces little or no movement in the bridle cables, then the bridles are too tight, and should be loosened.

There is a set of measurements for checking the bridle adjustment on the compliance verification specification sheet in this manual. These measurement are only for reference, and for use as a starting point. The "just slack in flight" criteria as described above are the final and only way to achieve proper bridle adjustment.

Bridle adjustment can and will change as cables stretch or if tuning changes are made. It is very important that you continuously monitor and re-adjust your bridles.

TURN TRIM

Turn trim is accomplished by appropriate adjustments of the leading edge sail tension and batten tension, and or by adjusting the twist in the rear leading edge sail mount plugs. See the service section of this manual for a detailed explanation.

FRONT TO REAR WIRE LOOP TENSION

This may be adjusted with the washers under the bottom rear wire tang. See the service section of the manual for detailed instructions.

SPORT MAINTENANCE

You should continually maintain your glider in a proper state of tune to insure optimum performance and flight characteristics. In addition, we recommend regular lubrication with silicone spray for three areas of the glider: the zipper on your glider bag, the zipper in the bottom surface of the sail, and the batten pockets. Periodically spraying the zippers, and spraying silicone lubricant into the ends of the battens pockets, will provide lubrication that will extend the useful life of these components. You should not use any other type of lubrication such as petroleum based lubricants.

Your SPORT should have a complete maintenance inspection every six months or 30 hours of airtime, whichever comes sooner, or at any time that you have reason to believe that any component may have been damaged.

Maintenance and service should be performed by your Wills Wing dealer.

THE NEXT THREE PAGES
DO NOT APPLY TO
THE SPORT AMERICAN

A WORD ABOUT THE SPECIAL ALLOY TUBING IN YOUR AIRFRAME

The leading edges, keel, and crossbars on your SPORT are all constructed of a special, high strength alloy of aluminum known as 7075-T6. Because this alloy has up to twice the ultimate strength of 6061-T6, which has been the hang gliding industry standard up until now, we were able to design a substantially lighter weight airframe for the SPORT without any sacrifice in strength by using tubing of the same diameter and thinner wall. A typical wall thickness when using 6061-T6 is .049 inches, while the wall thickness of the 7075-T6 tubing in the SPORT is .035". A number of areas of concern have been raised with regard to this tubing which we would like to address.

1) WEAKENING FROM DENTS AND DINGS

At first glance, a thinner wall tubing might be thought to be more susceptible to weakening from dents arising from random impacts during handling or racking of the glider. We have done carefully controlled tests of the dent susceptibility of the 7075-T6 used in the SPORT and have found that in spite of the thinner wall, it dents no more easily than an equivalent diameter piece of .049 wall 6061-T6. We attribute this to the much higher ultimate strength of the 7075-T6. We will continue to recommend with the SPORT, as we have with all of our previous gliders, that you do everything possible to protect the glider from damage during handling or car-topping. We do not feel, however, that any extraordinary measures are necessary.

2) PROXIMITY OF YIELD AND ULTIMATE FAILURE POINTS AND LOW FRACTURE TOUGHNESS

If you have worked with 7075-T6 before, perhaps in the form of batten tubing, you know that unlike 6061-T6 and other softer alloys, 7075-T6 has a somewhat spectacular failure mode. The level of stress in the material which will cause ultimate failure is only slightly higher than the yield stress, and rather than yielding slowly in a plastic mode, 7075-T6 has a tendency to snap or fracture suddenly when it fails. This "lack of warning" or lack of progressive plastic failure does not imply any necessary deficiency in the material. It does mean that when forming bent parts from 7075-T6 (battens for example) one has to be careful to use the proper methods for obtaining the desired yield in the material. It also means that if you bend a 7075-T6 spar far enough to bend it, you will probably break it in the process. It also means that if you hit it hard enough against something hard, you will be more likely to fracture it than you would be to crush it. Once again, however, because of the extremely high strength of 7075-T6, spars such as leading edges for example will bend much farther before breaking than an equivalent 6061-T6 spar will bend before yielding or taking a permanent set.

3) CORROSION AND STRESS CORROSION CRACKING

The alloy 7075-T6 is less resistant to some forms of corrosion, particularly stress corrosion cracking, than are many other aluminum alloys, including 6061-T6. The American Society For Metals, in a book entitled Aluminum Properties and Physical Metallurgy, states that "Under the combined action of a continuous tensile stress and a specific corrosive environment, rupture of some aluminum alloy members may occur by stress-corrosion cracking (SCC). In cases of extreme

susceptibility, the rupture of thick sections of 13mm (.5 in.) can occur in a short time (days). When stressed in the longitudinal or transverse directions, SCC may occur when stresses in the order of the yield stress are present. However, when stressed in the short transverse direction, for example across the flash line of a forging, SCC can occur at low stresses. Usually a chloride containing aggressive environment must be present, but in cases of extreme susceptibility, SCC can occur in humid air."

We have conducted and are continuing to conduct a number of "worst case" tests to determine whether SCC might be a problem for hang gliders made of 7075-T6. At present there are no indications that it will. The material has been used for years in Europe for hang glider and ultralight airframes without any reported problems that we are aware of. The reference in the literature to "chloride containing environment" as a causative factor leads us to recommend that you take particular care not to expose your airframe to prolonged contact with salt water. If you should happen to land in the surf, pull your sail and flush both the inside and outside of the airframe thoroughly as explained below.

If you do a lot of coastal soaring, and your glider is exposed to a lot of salt air or salt spray mist, you should consider periodically removing your sail and flushing your sail and airframe with fresh water. You **MUST** be sure to completely dry all components, both inside and outside after any such operation.

If we develop any further information that indicates that any special care or maintenance is required by the use of the 7075-T6 tubing, we will issue an appropriate advisory.

MINIMUM SERVICE SCHEDULE

EVERY SIX MONTHS

Complete maintenance inspection of sail and airframe (requires removal of sail from frame.) Replace any parts that show signs of wear. Have any tears or wear points in sail repaired by a professional sail maker.

Inspect all tubing for any signs of corrosion or cracking, especially around bolt and bushing holes and sleeve ends.

Inspect all cables for broken strands, kinks, cables out of the thimbles, corrosion, etc.

Inspect perlon hang loop for wear, replace if any wear is indicated.

Inspect bridle key rings for rust, and replace if necessary.

EVERY YEAR

Replace hang loops, harness suspension lines. Replace any cables that show kinking, wear, or corrosion.

SPECIAL CIRCUMSTANCES

Any time you suffer a crash or hard landing you should thoroughly inspect your glider and replace any parts that are bent or broken. Inspect the sail carefully for tears, especially along the trailing edge, at the rear leading edge attachment points, and at the kingpost cut-out. Have any sail damage repaired by a professional sail maker.

Inspect all holes in frame tubes for elongation, tearing, or cracking.

Even a simple ground handling mishap may cause concealed damage, such as bent battens, which could severely affect your glider's flight characteristics. If your glider flips over in the wind, or something similar happens, you should breakdown far enough to remove and inspect your battens, and perform a careful preflight after re-assembly.

If your glider is ever exposed to salt water you must rinse it thoroughly with fresh water, including the insides of all tubes. This will require the removal of all end caps. After rinsing, or any time your glider gets wet, you should dry it thoroughly, remove the endcaps for all tubes, and swab the insides of the tubes with a rag dampened with LPS-3.

Your sail should never be washed in anything other than fresh water, as any soap or detergent will likely degrade the cloth and may adversely affect the flying characteristics.

We recommend against the use of ARMORALL, AP 303, or other preservative treatments on your sail. These tend to lubricate the surface of the fabric so the point where seamstick tape will no longer adhere to the cloth. As a result, if your sail is ever damaged, it will be more costly to repair. Beyond that, you should know that we have seen no convincing evidence that any topically applied sail treatment of this type will do anything to protect your sail from damage from ultra violet light, or will extend the useful life of your sail.

If you set up or break down your glider in a sandy area, take care not to allow sand to enter your sail or batten pockets. This can best be done by placing something under the wing tips (your glider bag or harness bag) during any time they are resting on the sand, and by not dragging the trailing edge of the sail in the sand during set up or breakdown. Sand inside your sail, especially inside the batten pockets, will rapidly cause premature wear in that area.

IN CLOSING

With proper care and maintenance, your glider will retain for some years a high level of airworthiness. The SPORT was tested and found to comply with the 1986 HGMA Airworthiness Standards, which represent the best accumulated knowledge of what constitutes airworthiness in a hang glider. There is much that we still do not know, such as what is the effective lifetime for a hang glider before material fatigue and degradation compromise the glider's airworthiness. We do know that ultraviolet light (contained in sunlight) will cause progressive deterioration of the sail fabric, and we estimate that a sail which has had 200 hours of UV exposure will lose 30% or more of its structural strength. We recommend that you not expose your glider to any more solar radiation than necessary; do not leave it set up for long periods of time in the sun when you are not flying it, and always keep the coverbag on the glider when it is folded up.

We also know that there are forces in nature which can severely compromise your safety regardless of the quality of design or condition of the aircraft you are operating. Your safety is ultimately your responsibility. We strongly recommend that you fly conservatively, both in your choice of the conditions in which you fly and the safety margins you allow in the maneuvers you attempt. We recommend that you fly only with a harness that has been tested for strength by the manufacturer, and that you always fly with an emergency parachute system. Our experience has shown us that pilots who fail to follow these recommendations are often killed or severely injured in accidents that could easily have been prevented.

CAR TOP MOUNTING

Your SPORT should be mounted on your rack with the control bar bracket (zipper on the bag) facing upwards, and the flag at the rear. Your rack should have at least three support points, spanning at least 13' of the glider. These should be padded and at least 4" wide to distribute the load.

A FEW LAST WORDS

Your Wills Wing SPORT is a sophisticated high performance glider that will give you years of safe and enjoyable soaring, provided that you treat it properly and always maintain a healthy respect for the demands and potential dangers of flying. Please remember that aviation is always potentially dangerous, and that your safety depends on you. You are reminded that this glider is not covered by product liability insurance, and that you fly a hang glider at your own risk.

See you in the sky!

Wills Wing, Inc.

HGMA COMPLIANCE VERIFICATION SPECIFICATION SHEET

GLIDER MODEL: SPORT AMERICAN 167
MANUFACTURED BY: Wills Wing, Inc.

All dimensions in inches; weight in lbs.

NOTE: These specifications are intended only as a guideline for determining whether a given glider is a certified model and whether it is in the certified configuration. Be aware, however, that no set of specifications, however detailed, can guarantee the ability to determine whether a glider is the same model, or is in the same configuration as was certified, or has those performance, stability, and structural characteristics required by the certification standards. An owner's manual is required to be delivered with each HGMA certified glider, and it is required that it contain additional airworthiness information.

- 1) Weight of glider with all essential parts and without coverbags and non-essential parts: 66
- 2) Leading Edge Dimensions
 - a) Nose plate anchor hole to:
 - 1) Crossbar attachment hole: 131
 - 2) Rear sail attachment point: 230.75 - 232.25
 - b) Outside diameter at:
 - 1) Nose: 2
 - 2) Crossbar: 2
 - 3) Rear sail attachment point: 2
- 3) Crossbar Dimensions:
 - a) Overall pin to pin length from leading edge attachment point to hinge bolt at glider centerline: 119.9
 - b) Largest outside diameter: 2.25
- 4) Keel Dimensions; least and greatest allowable distances from the line joining the leading edge nose bolts to:
 - a) The xbar center load bearing pin: 41-42.5
 - b) The pilot hang loop: 59 - 60
- 5) Sail Dimensions
 - a) Chord lengths at
 - 1) 3 ft outboard of centerline: 76.5"
 - 2) 3 ft inboard of tip: 45.25
 - b) Span (extreme tip to tip): 402
- 6) Location of Information Placard: Keel
Location of test fly sticker: Keel
- 7) Recommended pilot weight range: 140-240
- 8) Recommended Pilot Proficiency: III

NOTE: Stability in pitch is provided by reflex in the root section, which is determined by the lengths of the kingpost, control bar, and front to rear top and bottom wires; by washout tips, which are factory set at 11 degrees above the horizontal plane and cannot be adjusted, and by reflex support bridles running from the kingpost to the trailing edge at the number 5 and 7 battens. Correct attachment and proper adjustment of these bridles is critical to adequate safety of the glider. Proper adjustment is described under "Reflex Support Bridles" elsewhere in this manual. The bridle measurement specifications, from top front wire at kingpost cap to batten pocket seam pencil line at trailing edge are;

Inner: 70.75" Outer: 120.25"

Service Section

INTRODUCTION

This section of the manual is intended for the use of Wills Wing dealers performing service on the glider. This manual assumes a high degree of familiarity with hang glider service procedures, the use of appropriate tools, etc. We strongly recommend that all service procedures be performed by a qualified dealer. We know of several serious accidents which were caused by improper assembly of glider components during service procedures done by pilots unfamiliar with general practices of glider design and assembly. When doing service work on a hang glider, please be absolutely sure you know what you are doing; someone's life will depend on it. There are numerous drawings and diagrams in this manual to help you understand the proper assembly of the glider. If you have any questions which you cannot answer after studying the manual, please contact Wills Wing.

POST SHIPMENT ASSEMBLY

Part of your required service as a Wills Wing dealer is to unpack, assemble, inspect and test fly each glider before you deliver it to the customer. The following instructions cover this pre-delivery procedure.

If the glider has been shipped full length, it requires no assembly other than the normal set up procedure described earlier in the owner section of this manual. Please refer to that section.

If the glider has been broken down for shipment, the rear leading edges will have been removed, and will need to be re-installed.

1) Remove the glider and parts from the shipping tube, unzip the bag, and spread the leading edges slightly. The rear leading edges should be marked to indicate right and left. Remember that with the glider lying on its back, the right leading edge will be on your left, as you look from the tail of the glider. Also notice that each rear leading edge has two 3/16" clevis pin holes in the forward end. This is so each leading edge can be used as either a left or right. It is important that you use the proper clevis pin hole to secure the leading edge in place. When the leading edge is properly installed, the plug in tip sleeve will point up and in, at an angle of about 11 degrees from the horizontal. If improperly installed, the sleeve will point either outwards, which would make it impossible to assemble the glider, or in and down at 11 degrees from the horizontal, which would put 11 degrees of negative twist in the tip and make the glider extremely unsafe to fly. Please note that when the glider is lying on its back (when the zipper on the bag is up) the tip sleeves will point "down" and in when properly installed, since the glider is upside down. The clevis pin should be installed from below the leading edge (from the top with the glider upside down) with the safety ring installed on top of the leading edge. Proper orientation of this clevis pin is shown in the exploded view of the leading edge / crossbar junction in section three of this manual.

2) Once the leading edges are properly installed and secured with the clevis pin and safety, the sail may be mounted to the rear leading edge. Make sure that the leading edge sail mount plugs are installed properly over the end of the leading edge, with the slot in the plug slid over the stud on the rear leading edge. Pull the sail back and slide the webbing anchor loop over the end cap on the end of the sail mount plug. Make sure that the webbing is properly seated and lying flat across the center of the endcap, and that it is captured by the raised portion of the cap.

Anytime you are mounting or dismounting the sail at the rear leading edge, check the condition of the webbing loop which secures the sail. If it is worn, have a sailmaker replace it. Also check to see that the sail mount plug is properly aligned and secured in alignment by the stud.

3) When mounting the sail at the rear of the leading edge, you may find it difficult to stretch the sail back far enough to install the webbing over the end of the plug. If so, you can dismount the sail at the nose by cutting or untying the string which holds the sail forward at the nose. If you do dismount the sail at the nose, you should remount it immediately after mounting the rear, and then tighten this mounting after setting up the glider. Otherwise the sail will slide rearward on the frame at the nose, and when you spread the leading edges during set-up, you will tear the sail at the nose. When remounting the sail at the nose, be sure to mount it tight enough so that the string will remain in place when the glider is set up and broken down again. With the glider set up, the string across the nose will be much looser than with the glider broken down and the leading edges folded in. Therefore, when tying the string with the wings spread, you should make it just slightly slack. When tying the string with the leading edges folded in, you should make it very tight. You probably won't be able to adjust it tight enough if you are tying it off with the leading edges folded in. In this case, readjust the nose string tension after you have the glider set up.

On early Sports there are two velcro tabs inside the sail at the rear of the leading edge which wrap around the leading edge and secure the sail against riding away from the leading edge which would allow the webbing loop to slide off the endcap. These must be fastened together after installing the sail mount webbing onto the rear leading edge endcap, and they must be unfastened prior to dismounting the sail from the endcap.

SET UP, INSPECTION AND TEST FLIGHT

Following removal of the glider from the tube and installation of the leading edges (if necessary) set up the glider according to the instructions in the owner section of this manual. Before inserting the battens, check them against the pattern and recamber any that may have been altered in shipping.

When installing the battens, check that the batten strings are properly adjusted, and re-adjust any that require it. Proper adjustment of the strings will allow you to pull the string just past, but not more than 1/4" to 3/8" past the end of the batten. If the strings are too loose, particularly on the outboard battens, the sail may flutter at the trailing edge. Batten strings which are attached with a single trailing edge grommet (inboard battens) should be a little looser than the strings which go through two grommets (outboard battens).

Following set-up, perform a complete pre-flight inspection of the glider as described in the owner section of this manual. Make sure to check carefully for proper alignment of the sail mount plugs, and symmetrical tensioning of the sail on the leading edges and symmetrical tensioning of the battens. Refer to the sections in this manual which cover leading edge sail plug adjustment and leading edge sail mount tension adjustment.

During this pre-flight inspection, don't assume that the glider is properly put together just because it came from the factory. At this point in time it becomes your responsibility to make sure that the glider you deliver to your customer is right, in every respect. If you find anything during the inspection that doesn't look right, and if after consulting the appropriate sections of this manual, you can't figure it out, contact Wills Wing.

After you have inspected the glider, the next step is the test flight. You should fly the glider from a familiar site in mellow conditions. During the test flight, perform the following maneuvers:

1) Multiple 360 degree turns at shallow bank angles in both directions. This is the best way to detect a turn in the glider; it will feel mildly roll stable to one side and mildly roll unstable to the other. Properly tuned, the glider will be essentially roll neutral, and will be equally so to both sides.

2) Low speed roll initiation from wings level. This is a test for adverse yaw; the tendency of a glider to resist rolling and yaw in the wrong direction at low speeds. Some degree of adverse yaw may be present at very low speeds, but from trim speed on up, the glider should roll in smoothly with good coordination, and should not require you to pull in on the bar prior to roll initiation.

3) Sustained, pilot full forward dives. The bar pressure in a dive is mild, but should be smooth, progressive and consistent. If it is not, carefully check the bridle settings, the alignment of the sail mount plugs, and the batten camber.

If the glider exhibits any improper flight characteristics, refer to the tuning section of this manual and try to correct the problem. Fly the glider between each adjustment to check on your progress. Do not deliver a glider until it has exhibited in flight the proper flying characteristics. Refer to your Wills Wing Dealer Test Pilot's Manual for further information on test flying. If you have a problem you cannot solve, please contact Wills Wing.

The final steps in your glider delivery procedure are to review the set-up, breakdown, and transport procedures, as well as the owner's manual with your customer. Fill out the glider delivery checklist, have your customer initial it, and send it in. Also, please encourage your customer to send in his customer response form.

TUNING

There are a number of things on the glider that are adjustable. We will cover the effects of adjusting each.

BATTENS

The battens will need to be trued to the pattern from time to time. Repeated installation and removal will tend to de-camber the battens. Hard landing and nose-ins may bend the tip battens or induce reflex into the #3, #4 and #5 battens. (Note: Battens are numbered from the tip inboard.) Small variations in batten camber will not have a significant effect on flight characteristics. Excessive camber in the battens will usually make the glider trim faster, have less bar pressure in a dive and be less pitch stable, and be stiffer and slower to roll. Too little camber will reduce the performance of the glider. Battens which are assymetric from left to right will tend to induce a turn in the glider.

The best way to true battens is in the shop on a flat table, using a radiused wooden template. Try to avoid putting sharp kinks in the batten. Unlike structural frame members, battens may be bent and re-bent repeatedly without causing any safety hazard. However, you may find it easier to replace a badly bent batten than to re-true it. When re-shaping a batten the material will tend to spring back after it is bent, so some practice is required to arrive at the proper final bend. We recommend against truing battens to the pattern outside the shop. In the field a bent batten can be trued to it's corresponding batten from the other side. As long as the battens are symmetrical and close to the proper shape, the glider will fly normally. When truing the battens to the pattern, line up each end of the batten underneath the line on the pattern, and check for the deviation along the batten as described on the pattern.

See page 1-57

TURN TRIM

We have identified several things which can cause a turn in a glider; asymmetric sail tension, asymmetric sail twist at the tip mount, asymmetric frame twist at the junction of the front and rear leading edges, asymmetric sweep wire lengths, creased or folded under mylar on one side, asymmetric batten shape or tension. If you have a turn, check all of these things before you try to tune the turn out. If you don't know how to check one or more of these items, and you cannot find an adequate explanation in this manual, call Wills Wing.

LEADING EDGE SAIL TENSION

Proper leading edge sail tension is important in determining the performance and flight characteristics of the SPORT. If the sail is mounted too tightly, the glider will be "stiff;" hard to turn with lots of roll bar pressure, and with a strong tendency to adverse yaw on turn initiation, especially at low speeds. If the sail is too loose, the handling will feel mushy and disconnected, and the glider will not perform as well as it should. The sail will stretch over time, so a new sail which is properly tensioned will eventually become too loose. A good time to consider re-tensioning your sail is after the first 50 hours of air time.

Note: A glider on which the sail is properly mounted will not handle better if the sail is loosened further; it will not get any easier to turn, and the qualitative characteristics will probably deteriorate.

Symmetrical leading edge sail tension is important on the Sport for proper turn trim. Leading edge sail tension is adjusted by installing 2" diameter shims of varying thicknesses over the sail mount plugs at the rear of the leading edges. The xbar must be detensioned and the wings partially folded in in order to remove the sail mount plug. The best way to see the change in sail tension or to measure the degree of asymmetry in sail tension is to look at the relationship between the front hem of the sail and the edge of the noseplate when the glider is fully set up. The further back from the edge of the noseplate the hem is, the tighter the sail.

A SPORT with a sail mounted assymmetrically on the leading edges will normally have a turn towards the looser wing. That is, if the left wing is mounted farther forward on the leading edge (looser) the glider will probably have a left turn. It is sometimes difficult to see whether or not the sail is mounted symmetrically. We recommend that you take two measurements: The distance that the hem at the nose rides underneath the noseplate or the distance the hem lies behind the edge of the noseplate, and the distance from the washout tube to the corner of the reinforcing patch on the sail. If you find an assymetry and the glider has a turn, correct the assymetry and see if the turn goes away. The last analysis is in the flight characteristics of the glider; if the glider flies properly, it is tuned properly.

Resist the temptation to draw conclusions about the tuning, the sail tension or the symmetry of the glider based on how high the sail flies above the washout tips. Very small variations in manufacturing tolerances can cause the height of the ends of the washout tips to vary from one glider to another, and from side to side on one glider. It is just as likely that a difference you observe in the height of the sail from the tips in flight will be due to variations in the frame as it is that it will be due to variations in the effective "twist" or angle of attack at which the sail at the tip is flying.

Remember that anytime you change the adjustment of the leading edge sail mount tension you will have to readjust the number one batten strings. The knot on this batten string is formed by two overhand knots, each of which is formed around the other end of the string, and which then pull together and lock. To re-adjust the knot, grasp each strand of the string which forms the finger pull loop, and pull until the knots slide apart. Then loosen one knot and reposition it along the string to readjust the final length of the batten string loop.

SAIL MOUNT ALIGNMENT

The sail mount rotational alignment at the tip is maintained by the channel in the plastic endcap which holds the sail mount webbing. This alignment affects the relative tensioning of the top and bottom surface of the sail at the tip, the twist of the tip in flight, and hence turn trim of the glider. This rotational alignment can be adjusted to remove a turn from the glider.

Normal proper adjustment of the rotational tip alignment will result in some slack in the bottom surface as the sail rests statically with the number two batten on the washout tip. As you raise the #2 batten off the washout tip, the bottom surface will go tight when the sail is about 2-4 inches above the washout tip. If you need to rotate the sail on one side to remove a turn, drill out the rivet which secures the plastic channeled endcap in the sail plug, and rotate the endcap. Rotate the endcap so as to twist the trailing edge up to slow down a wing, or down to speed up a wing. Rotating the endcap about one rivet hole diameter is a good place to start. Drill a new hole and install a new rivet.

Don't forget to check that the webbing is aligned within the channel of the endcap during pre-flight.

The longitudinal position of the pilot hang point is adjustable by moving the kingpost base fore and aft in the CG track extrusion. The procedure is to loosen the flex lock nut at the top of the kingpost base until you can slide the base in the track. Then position the base where you want it, and tighten down the nut until you feel it become snug as it bottoms out against the internal 3/8" steel sleeve. Then tighten it one more half turn. It is very important that this nut be fully tightened after every adjustment, so that the kingpost base cannot slide in the track in flight. After the nut is properly tightened, there should be about three threads showing above the nut. Over a period of time, or after several adjustments, or after a crash or hard landing, the steel inner sleeve against which the nut is tightened may become deformed, which could prevent you from adequately tightening the nut. You should therefore periodically dis-assemble this assembly and inspect the internal steel sleeve. Replace the steel sleeve if it is deformed, and replace the flex lock nut in any case. **Never re-mount the CG track to the keel turned end for end with the securing bolt at the back of the CG track.**

REMOVING AND RE-INSTALLING THE SAIL

There are a number of maintenance and repair procedures that require the removal of the sail from the frame. Please follow these instructions when removing and re-installing the sail. Please read all the instructions for each operation before beginning.

SAIL REMOVAL

You will need an unobstructed area six feet by thirty feet. Make sure the surface is clean. If it is abrasive, like rough concrete, you should either put down a protective tarp or be extremely careful not to scrape your sail.

- 1) Lay the glider on its back, unzip and remove the glider bag and put the battens aside.

2) Cut or untie the string sail mount at the nose, and then spread the wings slightly and dismount the sail from the rear leading edges. Remember to first undo the velcro tabs inside the sail at the rear if the glider is so equipped. Tape the sail plugs in position on the leading edge so that they do not become switched side to side (in case they are asymmetrically constructed with respect to the twist of the endcap or have asymmetric shims).

3) Unbolt the bottom side wires from the control bar. Detach the control bar E bracket from the U channel at the keel. Replace **the control** bar clevis pin and safety in the U channel so you don't lose them. Reinstall the keyhole tang bolt through the bottom rear wire tang with the washers in the same relative position as they were on the keel and put the locknut back on finger tight. The position of the washers relative to the tang and the keel affects the front to rear wire tension.

4) Turn the glider over. Unroll the sail until you can reach the bridle attachments at the trailing edge. Detach the bridles by removing the key rings. Unclip the bridles from the kingpost webbing strap, remove them from the glider and coil them and put them aside. Remove the screw that hold the kingpost top in place and the screw that secures the kingpost endcap. Remove the kingpost top, and then pop the endcap out by tapping a phillips head screwdriver through the hole in the bottom of the kingpost top. This procedure will also release the small white plastic rivet that keeps the top wires in place inside the cap. Remove the top wires from the cap.

5) Unbolt the kingpost base and control bar U channel from the keel. Detach the keel pocket restraining strap (at the rear of the keel pocket) from the keel. You need not detach the perlon hang loop from the kingpost nor the back up loop from the keel.

6) Undo the velcro which holds together the front part of the keel pocket. Slide the sail off the frame by pulling the frame out through the nose of the glider. The kingpost must stay with the sail, as the hang loop is looped around the keel and passes through the kingpost cutout in the top surface of the sail. If you encounter resistance, stop and figure out what is catching and free it. The nose of the sail is very tight as it goes over the crossbar center. Make sure the wings aren't spread apart and work the sail carefully over this part.

7) If you need to send the sail into the factory for repair, remove the mylar. It usually slides out the front of the pocket without undue difficulty. It helps to secure the rear end of the sail to something solid, so that you can lay the leading edge out straight and pull the mylar straight out of the pocket. If you have trouble getting it to slide freely out, it is probably because the edge of the mylar has worked its way into the seam and gotten stuck on the adhesive seamstick tape. Work your way up and down the leading edge pocket rolling the mylar away from the seam until it is free along its entire length. Fold and package the sail carefully if you plan to ship it in for repair.

RE-INSTALLING THE SAIL ON THE FRAME

1) Install the mylar in the sail. Make sure you install it right side up; the curved edge is at the front and on the bottom. The easiest way to install it is to push a long piece of string through the mylar pocket using a bottom surface batten or long stick, and then tie the rear end of the mylar to the string at the front of the sail and pull it into the pocket. It works best if you have one person feed the mylar into the sail at the nose while another pulls the string from the rear. Do not pull the mylar too far back into the pocket, and make sure that the hole in the mylar aligns with the top side wire hole in the sail when you are done.

2) Position the sail on the floor with the keel pocket up and the wings folded over so that the leading edges lie along the length of the root line, with the mylar pockets lying on top.

3) Prepare the frame, making sure that the side wires are pulled forward from the crossbar leading edge junction and are not wrapped around the frame. Pad the washout tip sleeves to protect the sail.

4) Position the frame with the bottom of the noseplate facing up and with the rear end of the leading edges at the nose of the sail. Slide the frame into the nose of the sail, making sure that the leading edges of the frame pass properly into the leading edge pockets of the sail and don't get caught at the rear of the bottom surface near the root. As you feed the frame slowly into the sail, check periodically to see that none of the hardware is snagging on the sail.

When the rear end of the keel reaches the keel pocket, you must feed the perlon hang loop through the hole in the sail and loop the perlon hang loop around the keel, making sure that the kingpost is properly oriented with the front facing forward, and that the spreader bar is below the keel. Then make sure that the keel feeds properly into the keel pocket.

When the crossbar center junction reaches the nose of the sail, it will be a very tight fit. Work the sail carefully over the junction and continue.

5) After the frame is fully installed, mount the webbing anchor loops over the rear leading edge endcaps, taking care that the webbing lies flat in the endcap slots and that the sail is properly aligned. Attach the velcro tabs inside the sail if the sail is so equipped. Install the nose sail restraint as tight as you can; you will need to tighten it further after the glider is set up.

6) Install the top and bottom side wires through the appropriate holes in the sail. This is most easily done by working through the "camera mount" zippers in the bottom surface which give access to the crossbar / leading edge junction. Make sure that no wire is wrapped around a leading edge or crossbar.

7) Bolt the bottom rear wires to the rear of the keel. Bolt the side wires to the control bar, installing the eyebolt first through the trapezoidal tang on the front to rear wires. Make sure that the long side of the trapezoid on this tang is closest to the sail. Bolt the control bar U channel and kingpost base to the keel, and attach the control bar to the U channel. Attach the bottom front wires to the noseplate and flip the glider upright onto the control bar.

8) Working through the center access zipper, push the top front wire through the sail. Assemble the top wires into the kingpost cap, install the white plastic rivet in the cap oriented such that the ears bear against the corners of the slots in the cap and secure the rivet in place. Install the black endcap, and install the screw which holds the black endcap. Install the kingpost cap into the kingpost, and install the screw which secures it.

9) Spread the wings slowly, checking frequently to make sure that the sail doesn't catch any of the hardware at the noseplate. Install the kingpost onto the base, and attach the bridles to the sail and to the clip.

10) Attach the keel pocket restraining strap, and finish the assembly of the glider according to the normal procedures.

11) Re-tie the nose sail anchor so that it is just slightly slack. Do a very careful preflight of the complete glider.

SPORT AMERICAN 167

6/11/86

MODIFIED 5-27-87

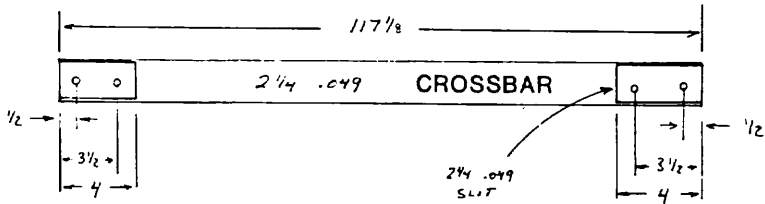
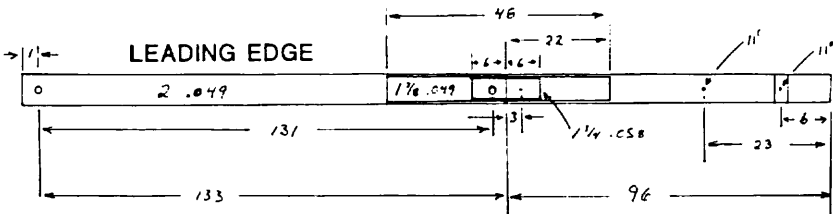
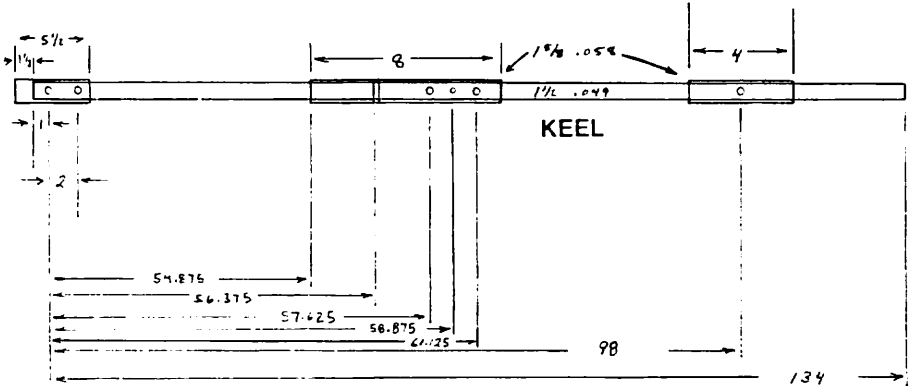

All dimensions in inches - All spars & sleeves are 6061-T6, all bushings are 6061-T6

CONTROL BAR

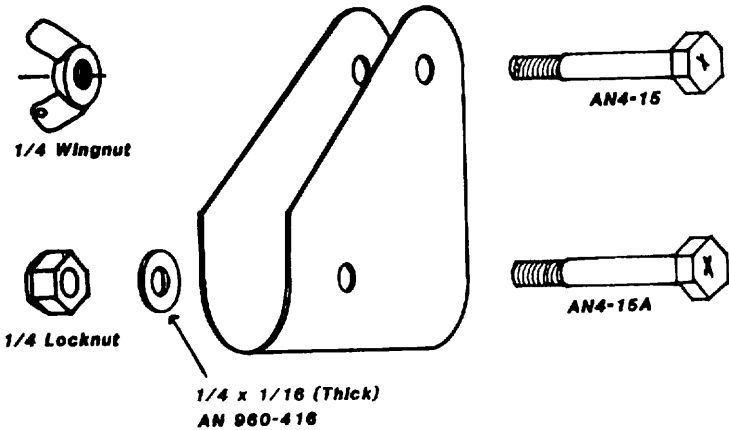
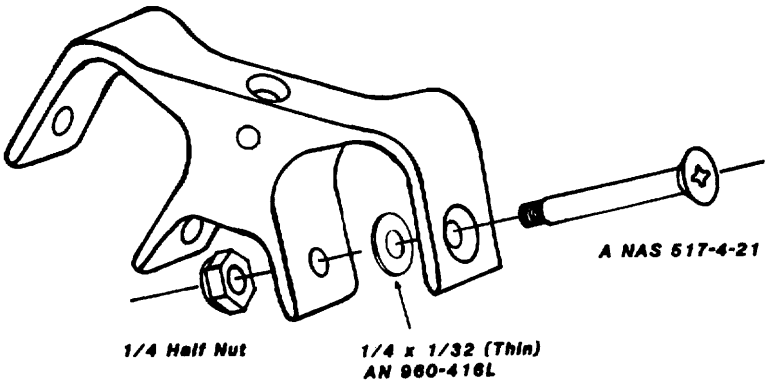

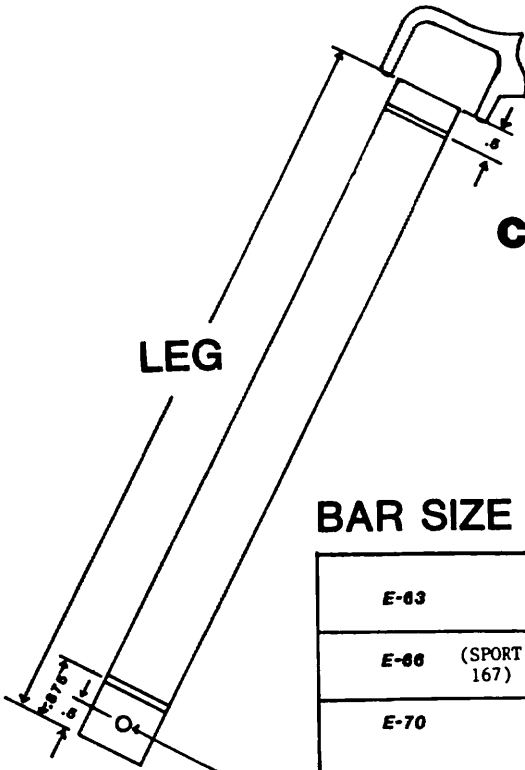

CONTROL BARS

BAR SIZE	LEG	BASE
E-63	63 1.125 x .068	54.5 1.125 x .058
E-66 (SPORT 167)	66.25 1.125 x .065	57.125 1.125 x .058
E-70	69.5 1.125 x .095	59.75 1.125 x .058

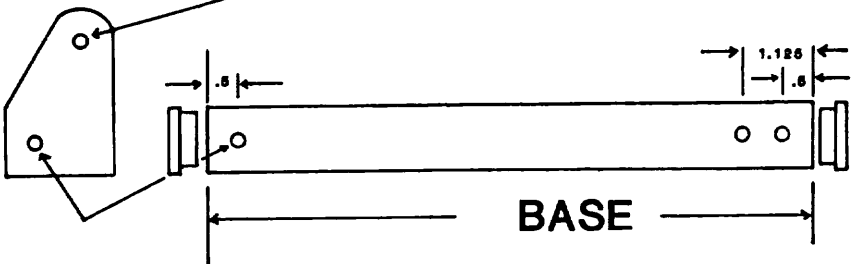

AN holes 1/4"

Not to scale

WILLS WING
Streamlined Downtube
Unsleeved Streamlined Tube:
1" x 2.5" x .049" wall

Streamline Adapter 6061-T6 (2 per piece)
1.125" OD x .058" Wall x 1.5" Long
Steps down to
.91" OD x .075" Wall x 1.25" Long

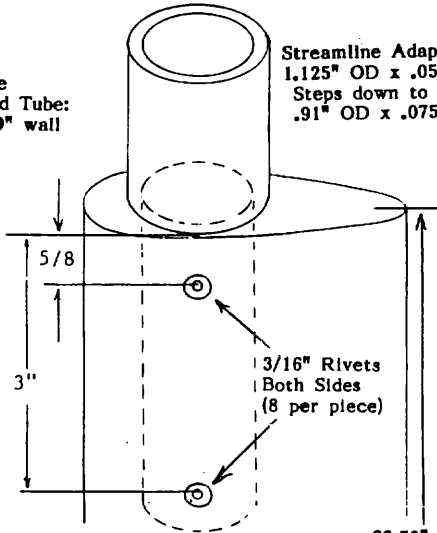

6061 T6 Streamline Tube
1" by 2.5" by .049" wall

66.50" (E-70)
63.25" (E-66)
60.00" (E-63)

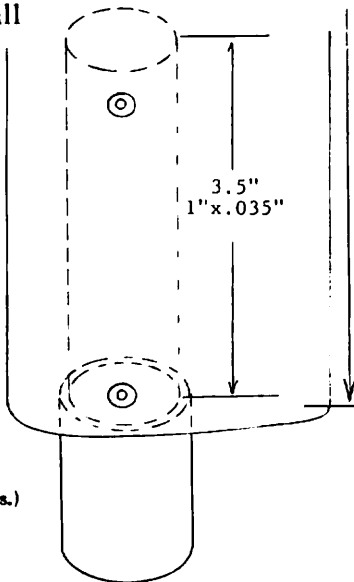

(Holes are not shown in streamline adapters. Hole locations are the same as are shown for the equivalent round downtubes.)

The installation of streamlined downtubes is not recommended on the Sport. If you do install them, you must mount the control bar top separately from and forward of the CG track, by moving the control bar top forward 7/8", and you must be sure to position the spreader bar just below the top edge of the faired portion of the streamlined tube before flight. (Separating and moving the control bar top forward will require that you eliminate the saddle and use shorter bolts in both applications; AN4-21A for each.)

NAS 623-4-38 (3)
(Alternate)

AN24-44
(3)

Small Safety
AN310-4
Castle Nut

Noseplate

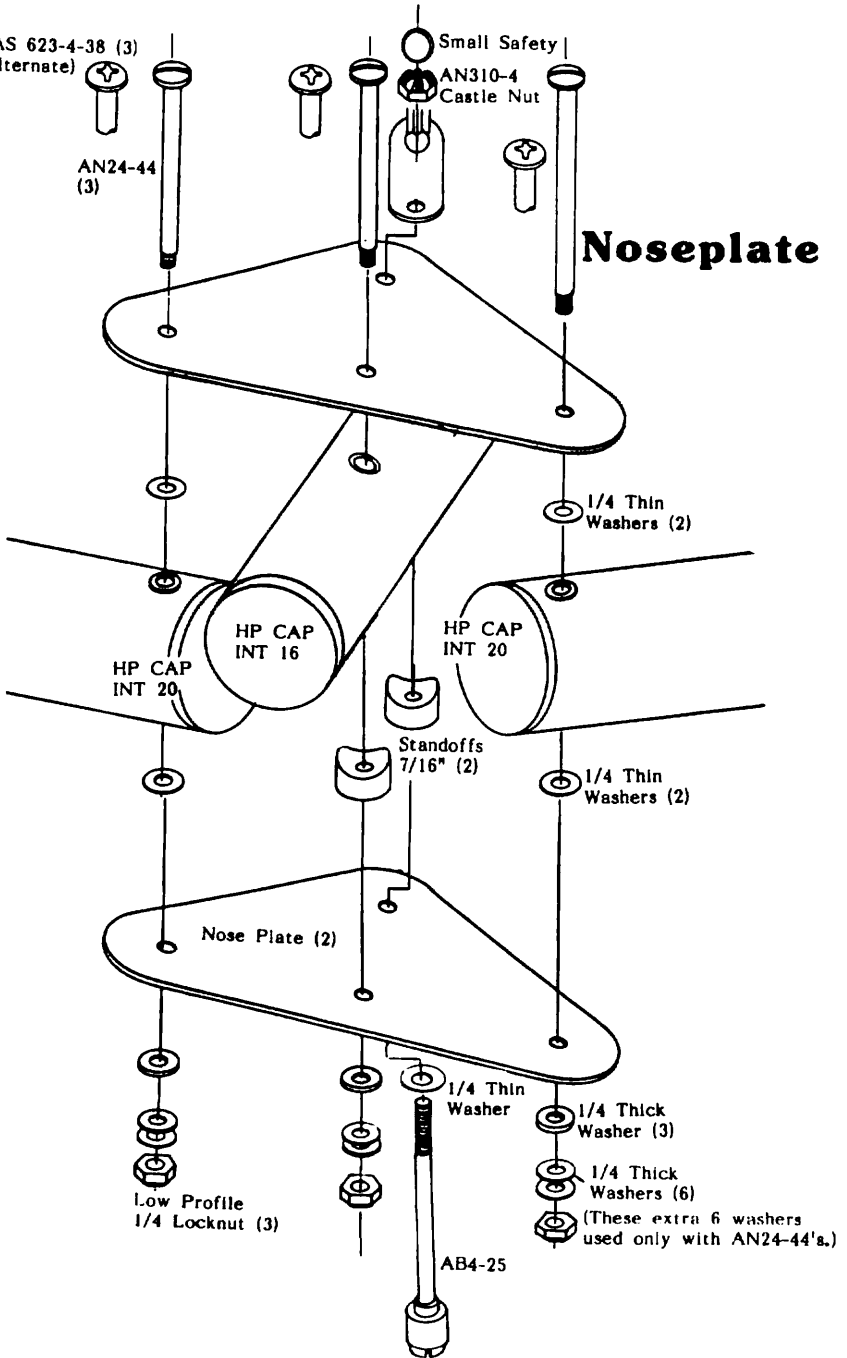

XBAR CENTER

SPORT AMERICAN 167 (3-25-88)

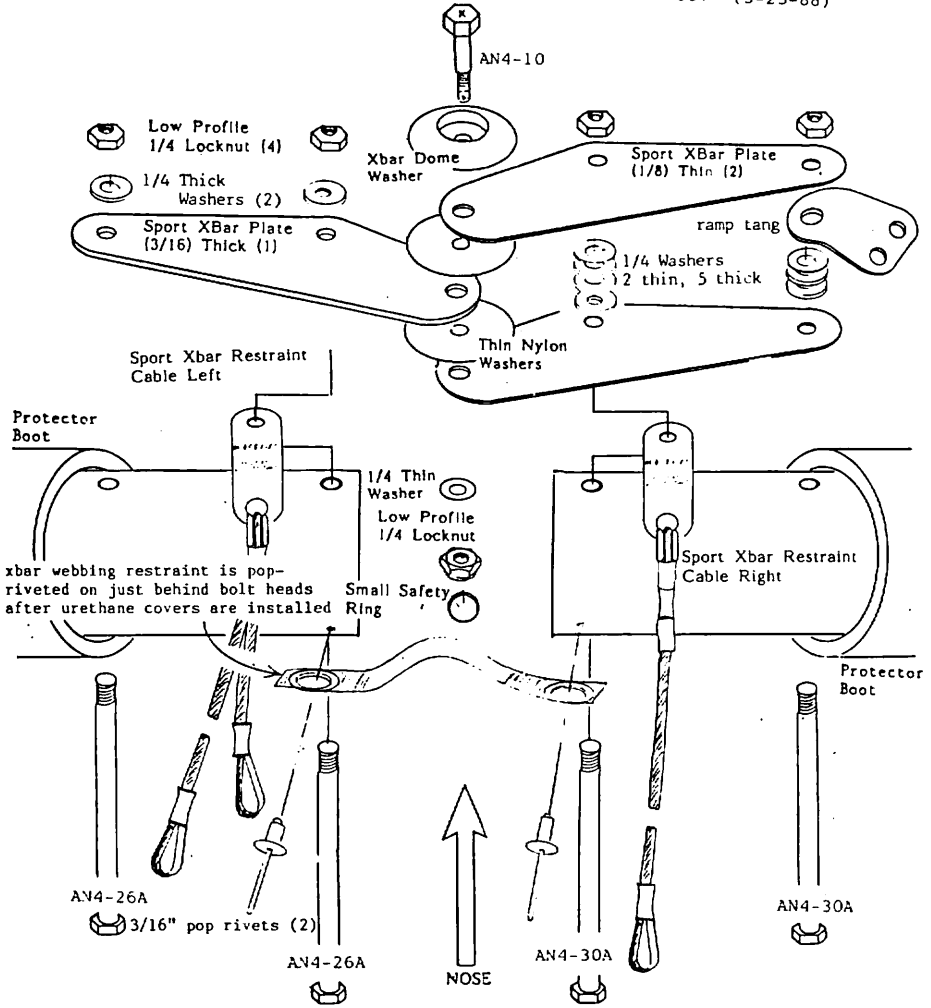

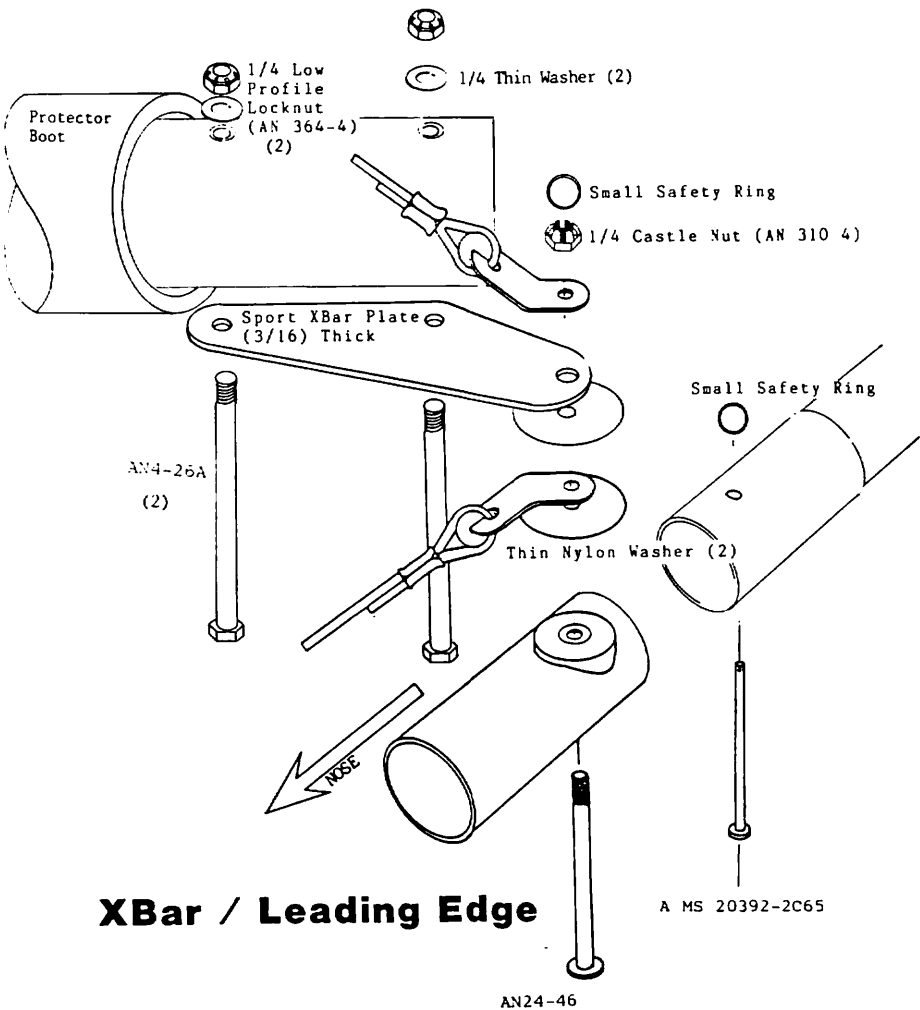

XBar / Leading Edge

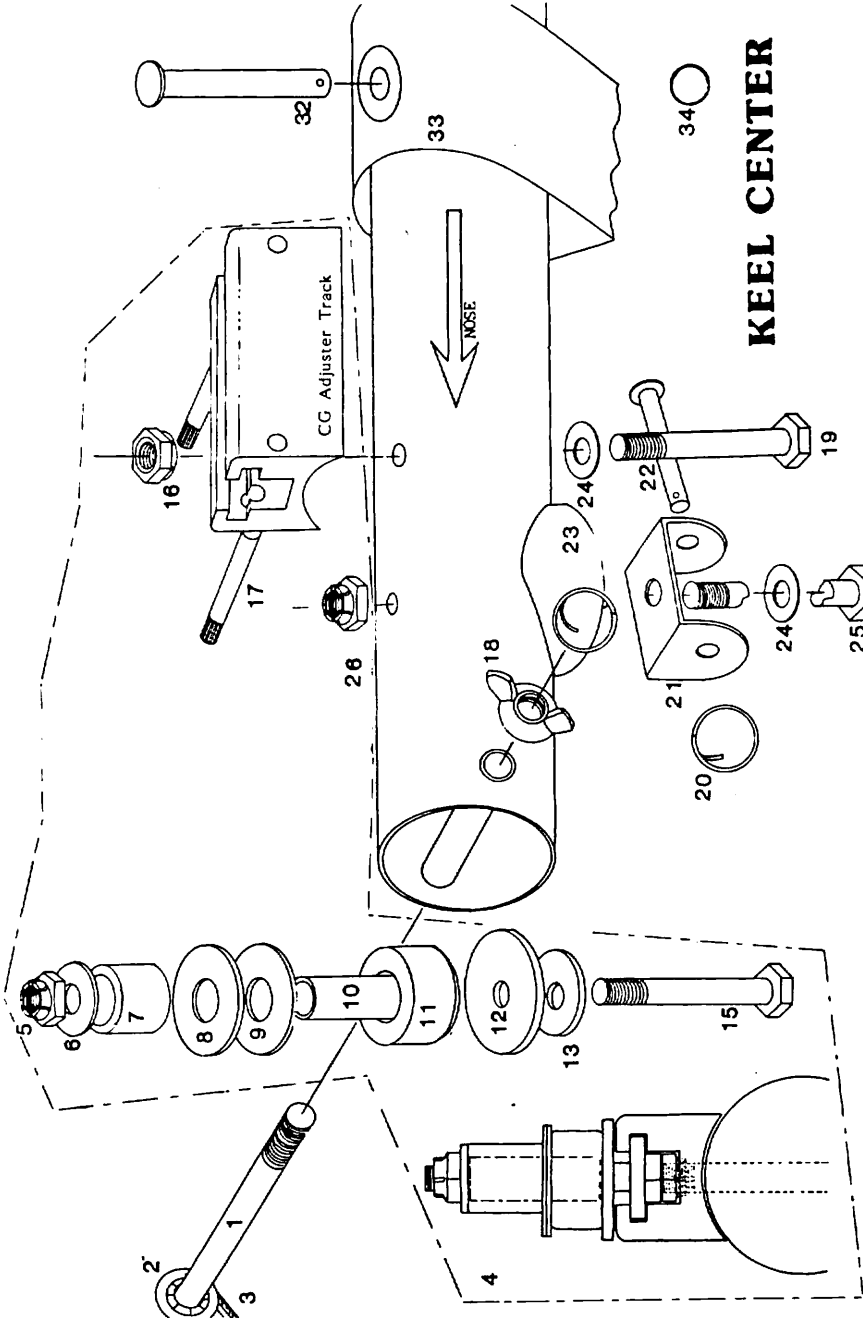

KEEL CENTER

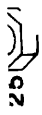

29

- 1 - AN4-26
- 2 - 1/4 Push Nut
- 3 - Xbar Restraint Cable, Right
- 4 - Adjustable Hang Point Kingpost
Base Assembly (LATE)- Assembled View

KINGPOST BASE ASSEMBLY - LATE

- 5 - 1/4 Flex Lock Nut (AN 21FK-428)
- 6 - Washer, Steel .625 OD, .275 ID,
.0625 Thick (MS 15795-210)
- 7 - Spacer, Aluminum .625 OD, .095 Wall,
.5625 Length
- 8 - Washer, Plastic 1 OD, .406 ID, x .062
- 9 - Washer, Steel 1 OD, .4375 ID,
.062 Thick, (MS 27183-15)
- 10- Spacer, Steel 4130, .375 OD, .058 Wall
1.125 Length
- 11- Rubber Grommet .875 OD, .375 ID
.5 Length
- 12- Washer Steel 1.125 OD, .25 ID,
.125 Thick
- 13- Washer Steel .75 OD, .25 ID,
.125 Thick
- 14- Deleted
- 15- AN4-16A
- 16- 1/4 Flex Lock Nut (Upside down)
(AN 21FK-428)
- 17- Knurled Pin, .1875 Diameter (2)
- 18- 1/4 Wingnut (AN350-4)
- 19 - AN4-20A
- 20- Large Safety Ring (2)
- 21- Control Bar Top U Channel
(HBP CB TOP)
- 22- Clevis Pin .1875 by 1.375
(MS 20392 2C41)
- 23- Saddle 1.5 (HP Saddle 14B)
- 24- Washer Steel Thin .5 OD, .25 ID
.03125 Thick
- 25- AN4-21A (Sport American & HP II)
- AN4-22A (Sport)
- 26 - 1/4 Flex Lock Nut
(AN 21FK-428)
- 27- Deleted
- 28- Deleted
- 29- Deleted
- 30- Deleted
- 31- Deleted
- 32- Clevis Pin .25 by 2.10
(MS 20392 3C63)
- 33- Hang Loop (Backup) E-70 Length
- 34- Small Safety Ring

REAR KEEL

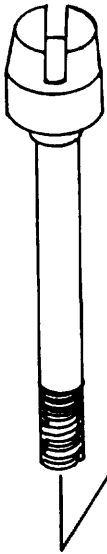

AB4-25A

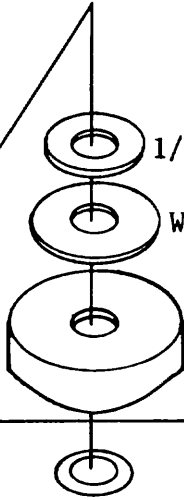

1/4 Thick washer (AN 960-416)

Washer (MS 15795-210)

HP Standoff 1/4

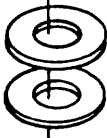

1/4 Thick washers (2)
(AN 960-416)

(0 to 4, To Adjust
Wire Tension)

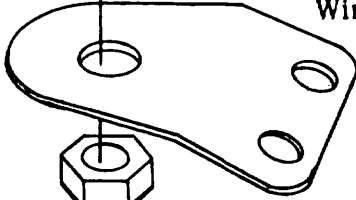

1/4 Locknut (AN 365-428A)

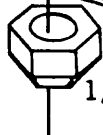

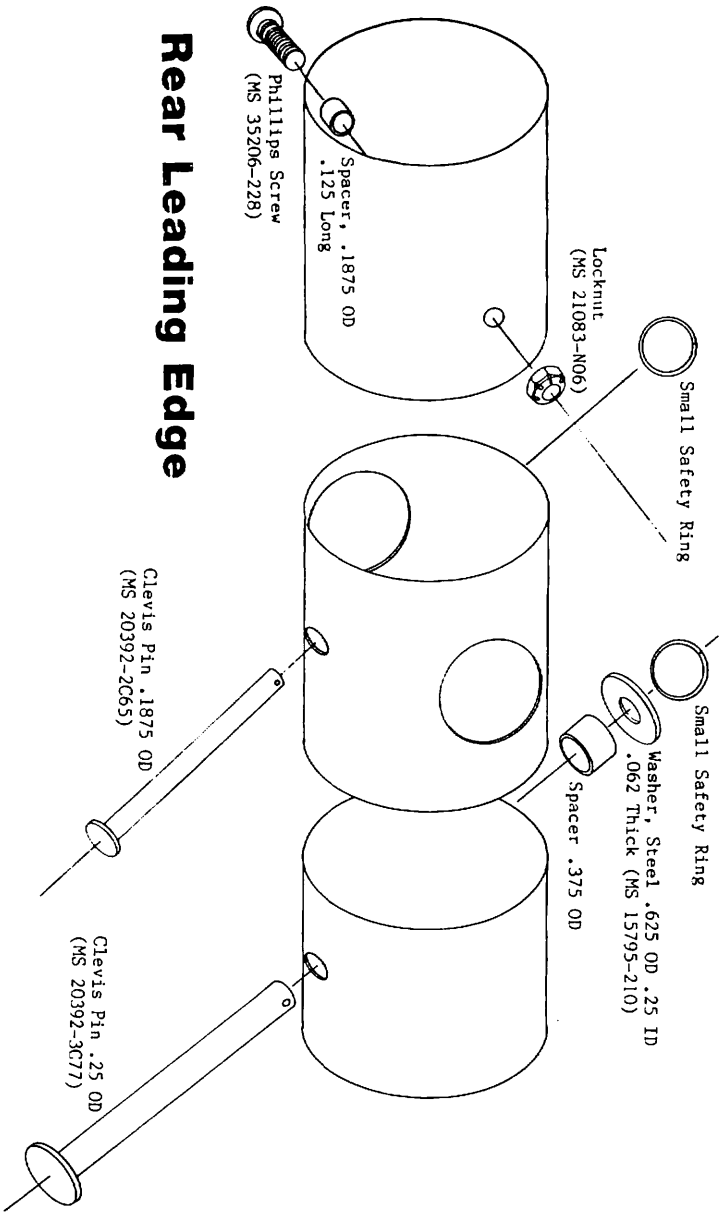

Rear Leading Edge

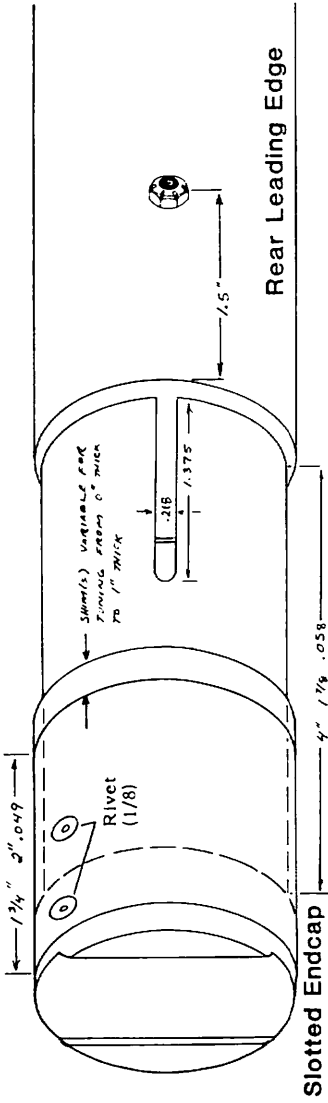

Sail Mount Plug (Assembled)

Kingpost

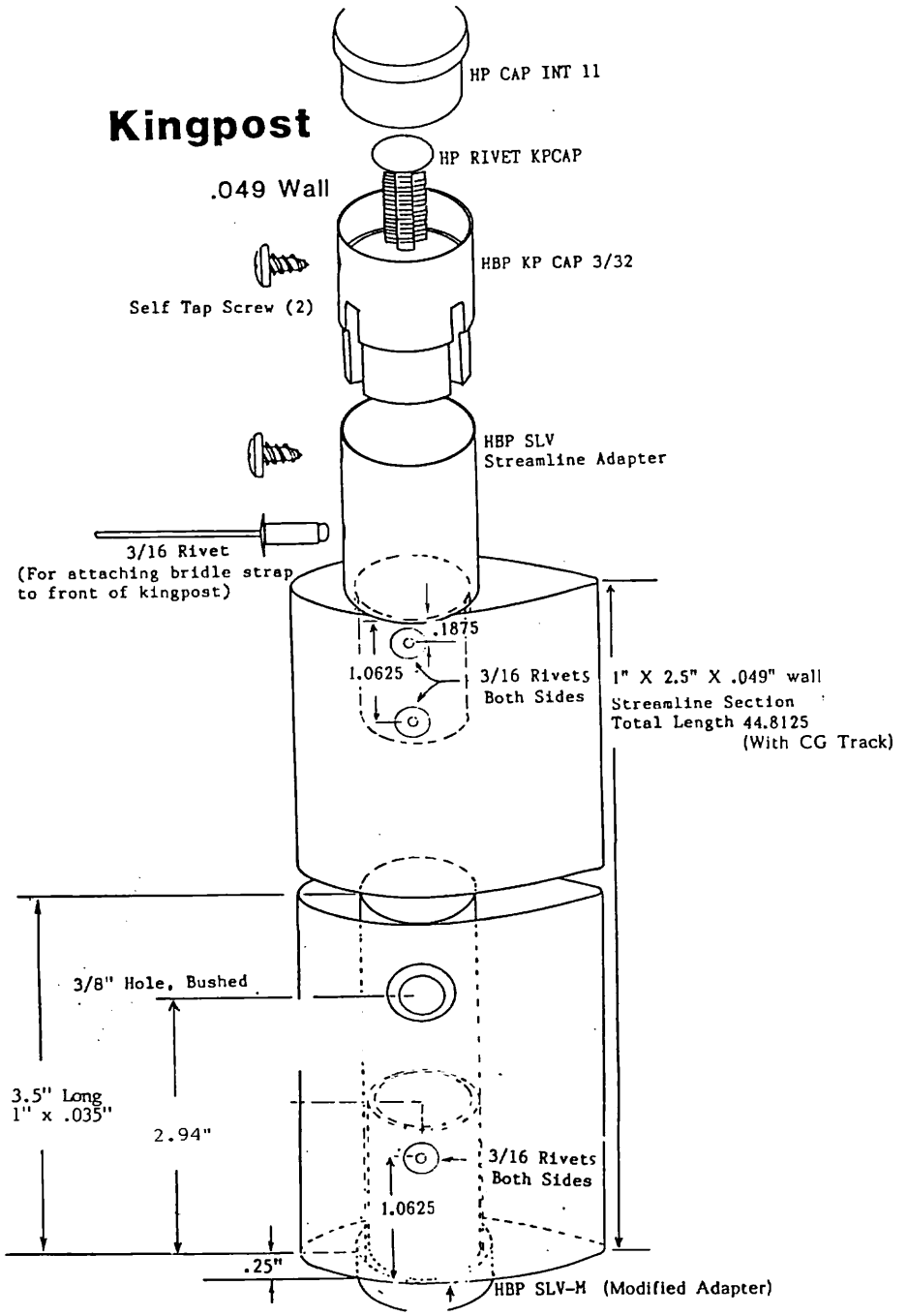

Kingpost Hang System

(Rear View)

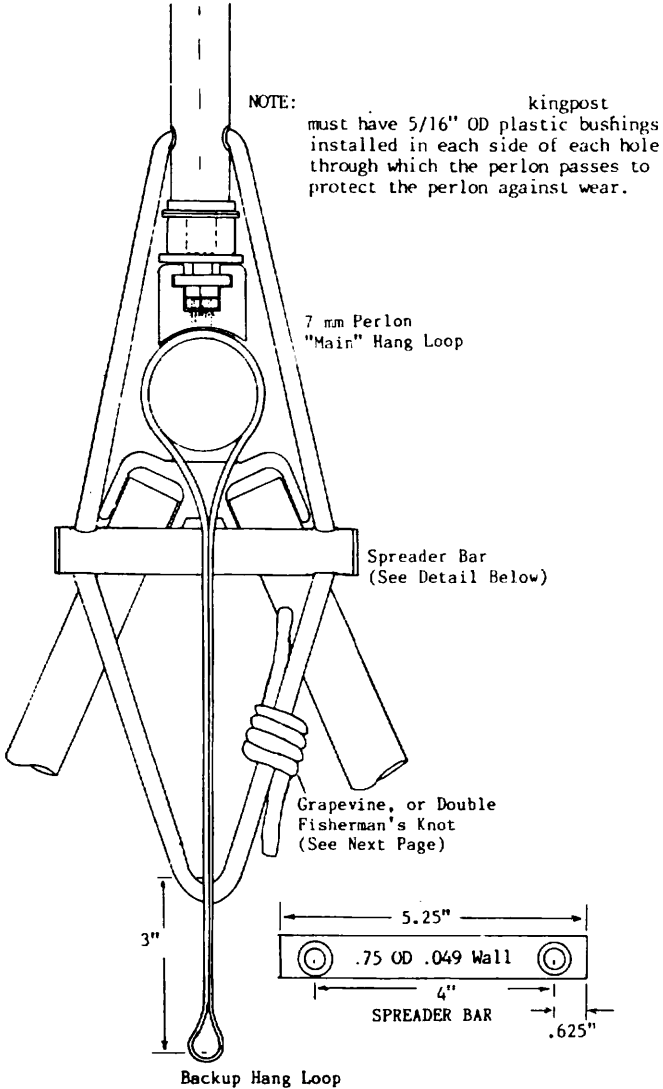

Grapevine Knot

Tying Sequence

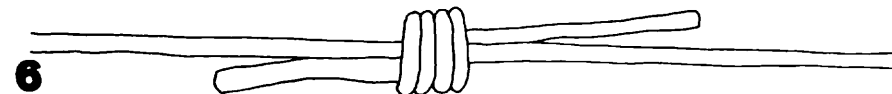
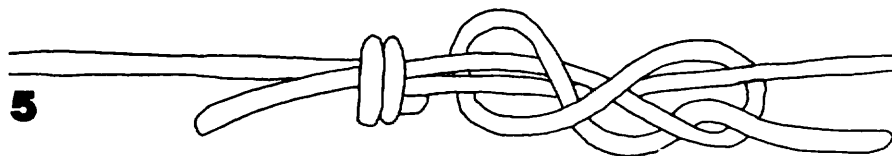
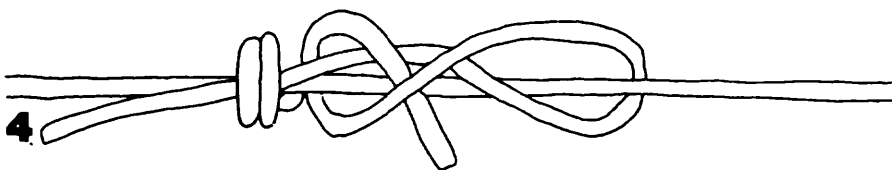
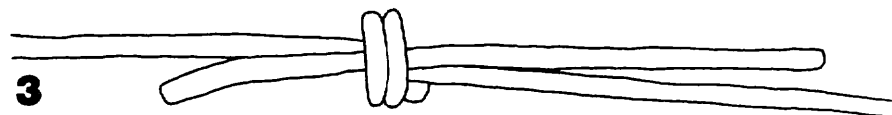
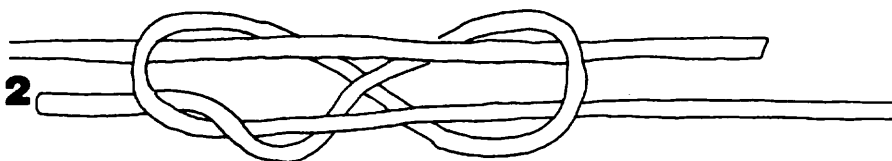
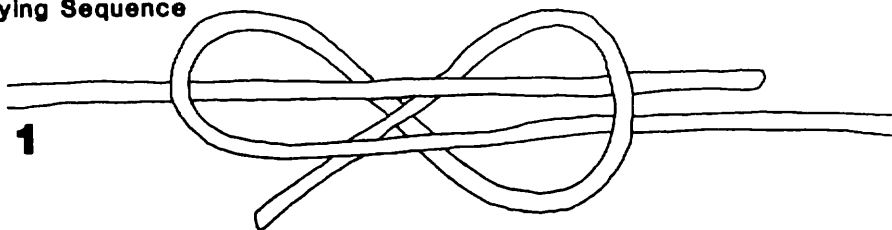

Washout Sleeves & Tips

